

SECTION 600

TRANSPORTATION SYSTEMS

		<u>Page</u>
600.01	DEFINITIONS	600-1
601.00	TRANSPORTATION SYSTEMS - GENERAL POLICY AND REQUIREMENTS	
601.01	Street Design.....	600-2
601.02	Functional Classification of Streets	600-3
601.03	Street Dedication	600-5
601.04	Street Access	600-5
601.05	Street	600-7
601.06	Street Extensions to the Property Line	600-7
601.07	Service Drives	600-8
601.08	Street Curb and Gutter	600-8
601.09	Street Lights	600-9
602.00	TRANSPORTATION SYSTEMS - PLANNING AND DESIGN	
602.01	Traffic Impact Analysis (TIA)	600-10
602.02	Transportation Demand Management (TDM)	600-10
602.02.1	Purpose	600-10
602.02.2	When a TDM Plan is Required	600-10
602.03	Trip Generation Standards	600-11
602.04	Design Speed Standards	600-11
602.05	Sight Distance Standards	600-11
602.06	Median Crossovers.....	600-12
602.07	Street Intersections	600-13
602.08	Street Cul-de-sacs	600-15
602.09	Street Grade and Layout	600-15
602.10	Street Pavement Design	600-16
602.11	Alternate Pavement Design	600-16
602.12	Paved Ditches, Underdrains and Guardrails	600-18
602.13	Street Lights	600-18
602.14	Privately Maintained Travelways and Parking Areas	600-19
602.15	Privately Maintained Travelway Pavement Design	600-20
602.16	Pipestem Driveways and Alleyways	600-21
602.16.1	Pipestem Driveways	600-21
602.16.2	Alleyways in Planned Districts.....	600-23
602.17	Common Driveways for Two Lots	600-24
602.18	Sidewalks/Shared Use Paths.....	600-24
602.19	Sidewalk/Shared Use Path Maintenance	600-25

602.20	Trail/Shared Use Path Safety Considerations	600-26
602.21	Trail/Shared Use Path Easements	600-26
602.22	Trail/Shared Use Path Grade and Drainage	600-27
602.23	Trail/Shared Use Path Bridges.....	600-27
602.24	Trail/Shared Use Path Steps	600-27
602.25	Street Planting	600-28

603.00 TRANSPORTATION SYSTEMS - SUBMISSION REQUIREMENTS

603.01	Traffic Impact Analysis (TIA)	600-28
603.02	Plans.....	600-28
603.03	Topographic Information and Grading Plans for Streets	600-29
603.04	Street Station Points and Centerline Curve Information	600-29
603.05	Street Sight Distances	600-30
603.06	Building Restriction Line Profiles for Streets	600-30
603.07	Street Centerline Profiles	600-30
603.08	Street Grade Lines and Cross Sections	600-31
603.09	Street Cul-de-sacs	600-31
603.10	Street Pavement	600-31
603.11	Street Curb and Gutter	600-32
603.12	Street Landings	600-32
603.13	Street Entrances	600-32
603.14	Street Ditches	600-32
603.15	Guardrails	600-32
603.16	Storm Sewer and Utility Lines in Relation to Streets.....	600-33
603.17	Stream Profiles in Relation to Streets	600-33
603.18	Street Slope Easements	600-33
603.19	Erosion Control for Streets	600-34
603.20	Street Lighting Plan	600-34
603.21	Street Barricades	600-34
603.22	Street Names	600-34
603.23	Street Names in Relation to Street Type	600-35
603.24	Street Addresses	600-36
603.25	Plats	600-37

604.00 TRANSPORTATION SYSTEMS - CONSTRUCTION STANDARDS

604.01	Street Construction	600-38
604.02	Street Curb and Gutter/Sidewalks	600-39
604.03	Paved Ditches, Guardrails and Retaining Walls and Noise Abatement Facilities	600-39
604.04	Street Signs	600-40
604.05	Street Traffic Control Signs	600-41
604.06	Street Name Signs	600-41
604.07	Privately Maintained Travelways and Streets	600-42
604.08	Privately Maintained Travelway Signs	600-43

604.09	Traffic Signal – VDOT and PWC Pre-Emption Systems	600-43
610.00	TRANSPORTATION SYSTEMS - OFF-STREET PARKING	
610.01	General Requirements for Off-Street Parking	600-43
610.02	Parking and Loading Spaces Required	600-45
610.03	Parking Credit Allowance	600-46
610.04	Parking Deferrals	600-46
610.05	Setbacks	600-46
610.06	Layout and Design	600-47
610.07	Off-Street Stacking Spaces	600-49
610.08	Accessible Parking	600-49
610.09	Layout and Design for Motor Vehicle Fuel Sales and Convenience Food Stores	600-50
610.10	Parking Lot Landscaping	600-50
610.11	Outdoor/Roadway Lighting	600-50
620.00	TRANSPORTATION SYSTEMS - TRAFFIC IMPACT ANALYSIS	
620.01	Title and Purpose	600-51
620.02	Administration	600-51
620.03	Study Area	600-52
620.04	Design Year	600-52
620.05	Traffic Data Requirements and Existing Conditions	600-52
620.06	Trip Generation	600-53
620.07	Future Traffic Conditions	600-54
620.08	Trip Distribution and Assignment	600-54
620.09	Analysis	600-55
620.10	Recommendations	600-56
630.00	TRANSPORTATION DEMAND MANAGEMENT (TDM)	
630.01	What to Include in a TDM	600-57
630.02	Administration	600-58
640.00	TRANSPORTATION CONSTRUCTION AND INSPECTIONS	
640.01	Comprehensive Inspection Program	600-60
640.02	Pre-Construction	600-61
640.03	Street Construction Inspection	600-61
640.04	Special Agreements	600-62
640.05	Street Acceptance	600-62

TABLES

Table 6-1	Trip Generation	600-63
Table 6-2	Design Speed for New Streets	600-63
Table 6-3	Design Speed for Existing Streets	600-63
Table 6-4	Stopping Sight Distance	600-64
Table 6-5	Intersection Sight Distance	600-64
Table 6-6	Crossover Spacing	600-65
Table 6-7	Minimum Turn Lane Requirements	600-65
Table 6-8	Required Loading and Off-street Parking Spaces	600-65
Table 6-9	Pump Island Setback	600-74
Table 6-10	Minimum Off-street Parking Area Dimensions	600-75
Table 6-11	Parallel Parking and Aisle Dimensions	600-75
Table 6-12	TIA Guidelines for Study Design Year Horizons	600-76
Table 6-13	Bike Parking for Specific Land Uses.....	600-77

650.00 TRANSPORTATION SYSTEMS - DETAILS

650.01	Standard Pavement Design	SPD-1
650.02	Residential Local Streets without Curb and Gutter (Fixed Traffic).....	RL-1
650.03	Residential Minor Collector Streets without Curb and Gutter ..	RM-1
650.04	Residential Local Streets with Curb and Gutter (Fixed Traffic)	RL-2
650.05	Residential Minor Collector Streets with Curb and Gutter	RM-2
650.06	Travelways for Industrial, Institutional, Office, Commercial, Single-family Attached and Multifamily Developments	TS-1
650.07	Condominium, Mobile Home and Apartment Streets with No Residential Frontage	MF-1
650.08	Commercial and Industrial Streets with Curb and Gutter	CI-1
650.09	Major Collector Streets as Designated by the Comprehensive Plan (4-lane Divided With Curb and Gutter).....	MC-1
650.10	Major Collector/ Minor Arterial Streets as Designated by the Comprehensive Plan (4-lane Divided Without Curb & Gutter)	MC-2/ MA-2
650.11	Minor Arterial Streets as Designated by the Comprehensive Plan (6-lane Divided With Curb and Gutter)	MA-1
650.12	Principal Arterial /Parkways as Designated by the Comprehensive Plan (8-lane Divided with Curb and Gutter) ...	PA-1
650.13	Principal Arterial /Parkways as Designated by the Comprehensive Plan (4-lane Divided Initially)	PA-2
650.14	Through Boulevard in Urban Centers.....	UTB-1
650.15	Boulevard in Urban Centers	UB-1
650.16	Avenue and Street in Urban Centers.....	UAS-1
650.17	Private Residential Street in Urban Centers.....	UPS-1
650.18	Private Alley in Urban Centers	UA-1

650.19	Street Tree Planting for Urban Centers.....	UST-1
650.20	Curb Extension Layout Design	CSL-1
650.21	Curb and Gutter for Service Drives	SD-1
650.22	Standard Cul-de-sac with Curb, Gutter and Sidewalk	CS-1
650.23	Offset (Left) Cul-de-sac with Curb, Gutter and Sidewalk	CS-2
650.24	Offset (Right) Cul-de-sac with Curb, Gutter and Sidewalk	CS-3
650.25	Offset Cul-de-sac with Curb, Gutter and Sidewalk (With Center Island)	CCI-1
650.26	Standard Cul-de-sac with Curb, Gutter and Sidewalk (With Center Island)	CCI-2
650.27	Standard Cul-de-sac on Ditch Section Street	DS-1
650.28	Offset (Left) Cul-de-sac on Ditch Section Street	DS-2
650.29	Offset (Right) Cul-de-sac on Ditch Section Street	DS-3
650.30	Travelway Turnaround Standards	TT-1
650.31	Travelway Turnaround for Emergency Vehicles and Service Trucks	TT-2
650.32	Pipestem Entrance Design with Curb and Gutter	PP-1
650.33	Typical Acceptable Pipestem Lot Layouts (Double Stacking)	PP-2
650.34	Intersection Landing Requirements	IL-1
650.35	Intersection Sight Distance Requirements	ISD-1
650.36	Bicycle Trail/Shared Use Path Standards for VDOT Maintenance	BT-1
650.37	Asphalt Park Trail (Not Eligible for VDOT Maintenance)	PT-1
650.38	Full Bench Cut Trail (Not Eligible for VDOT Maintenance) ...	CT-1
650.39	Hiking Trail (Not Eligible for VDOT Maintenance)	HT-1
650.40	Equestrian Trail (Not Eligible for VDOT Maintenance)	ET-1
650.41	Standard Sidewalk with Underdrains	SS-1
650.42	Alternative Entrance with Curb and Gutter	DE-1
650.43	Driveway Entrance with Curb and Gutter (Single family Detached)	DE-2
650.44	Driveway Entrance with Curb and Gutter (Single family Attached with Garage)	DE-3
650.45	Driveway Entrance with Ditch Section	DE-4
650.46	Curb Cut Ramp	CCR-1
650.47	Standard Road Edge Delineators	ED-1
650.48	Special Road Edge Delineators	ED-2
650.49	Standard Type III Traffic Barricade	TB-1
650.50	Shoulder Stabilization at Intersections	SI-1
650.51	Mailbox Location	MBL-1
650.52	Street Name Sign Standard	SNS-1
650.53	Street Name Signs on Tapered Aluminum Signal Poles	SNS-2
650.54	Thru Street Sign Standard	TSS-1
650.55	Dead End/No Outlet Street Sign Standard	DES-1
650.56	Private Street Sign Standard	PSS-1
650.57	Accessible Parking Space Standard	HP-1

650.58	Accessible Parking Standard for Two Adjacent Parking Spaces	HP-2
650.59	Electric Vehicle (EV) Charging Station	EV-1
650.60	Range Address Sign for Pipestems	RAS-1
650.61	Street Light Installation	SLI-1
650.62	Private Travelway Speed Humps	PTS-1
650.63	Asphalt Pavement Widening for Widening Subject to Traffic..	APW-1
650.64	State Maintenance Road Sign	SMS-1

SECTION 600

TRANSPORTATION SYSTEMS

600.01 Definitions:

- A. AASHTO: The American Association of State Highways and Transportation Officials.
- B. Alleyway: a privately maintained travelway primarily designed to provide a secondary access to the side or rear of properties whose primary frontage is on another street. Alleys may be allowed on single family residential, multi family, townhouse/single family attached, and commercial uses of town center developments.
- C. Bridge: A structure erected over a watercourse, depression, or obstacle (Webster's Collegiate Dictionary). As distinguished from a culvert, it is a large structure spanning a watercourse, the bed of which is left comparatively undisturbed. The opening width is generally large compared to the length (in the direction of flow). The structure generally consists of a deck or superstructure supported on two or more abutments or piers.
- D. Care Facilities: Hospitals, adult and/or child day care centers, nursing convalescent homes and their buildings and associated parking.
- E. Channelization: The design of a street intersection which separates conflicting traffic movements into definite paths of travel by the application of pavement markings, raised median or other appropriate means to facilitate the safe and orderly movement of both vehicles and pedestrians.
- F. Commercial/Retail: Buildings with uses that are primarily retail, or retail-related, including shopping centers, motor vehicle fuel sales, etc.
- G. Institutional uses: Churches, cemeteries, rescue squads, fire departments, police departments, libraries, school (public and private) and their related building and parking lots.
- H. MUTCD: The Manual of Uniform Traffic Control Devices.
- I. Office: Buildings with primarily administrative activities, including financial institutions.
- J. Pipestem driveway: Driveway or shared driveway servicing up to five (5) pipestem lots.
- K. Pipestem lot: A lot in a cluster development for which the minimum frontage for the zoning district in which it is located is not required to be met.
- L. Street, Public: A thoroughfare (street, drive, avenue, boulevard, etc.) which has been or is intended to be dedicated for public use, and which has been accepted or is intended to be accepted into the State system.

M. Street, Private: Where permitted, a privately maintained thoroughfare designed to provide access to private property.

N. Traffic study: A study conducted to assess the impact of traffic generated by a new use or change in use on existing or future road network, and to obtain the required information in evaluating any potential road network improvements.

O. Travelways: A directional path primarily used for vehicular movement, that is designed to provide access to parking bays and/or adjacent parking spaces and to and from privately maintained properties, commercial, industrial, single family attached and multifamily developments, whether or not in an easement or built to design standards. They are considered as private streets or roadways and are not intended for acceptance into State or County maintained roadway systems.

P. Use group: The classification of a building or structure based on the purpose for which it is used, as listed in the Virginia Uniform Statewide Building Code.

Q. VDOT: The Virginia Department of Transportation.

R. Vpd: Vehicles per day

601.00 TRANSPORTATION SYSTEMS - GENERAL POLICY AND REQUIREMENTS

601.01 Street Design:

A. The provisions of this section shall apply to all street design and construction in the County. Where no specific roadway construction, design standard, or specification is set forth in this manual, the provisions of the Virginia Department of Transportation (VDOT) Road and Bridge Standards, Secondary Street Acceptance Requirements, Minimum Standards for Entrances to State Highways, Road Design Manual - Appendix A, A Policy on Geometric Design of Highway and Streets Manual Current Edition of American Association of State Highway and Transportation Officials (AASHTO) and the Virginia supplement to the Manual of Uniform Traffic Control Devices (MUTCD) shall be used.

B. Northern Virginia has been designated as an urban area by VDOT subdivision standards. All streets shall be designed as set forth in this manual or by VDOT standards, whichever is more stringent.

C. The arrangement of major streets in a development shall provide for their proper continuation with developed adjoining properties, and for their proper extension into undeveloped adjoining properties. The proper interparcel connecting arrangement shall be accomplished by the use of stub streets and temporary cul-de-sacs, etc., which is intended to provide and maintain access for basic public services, to allow movement of vehicular, bicycle, and pedestrian traffic, and to provide a corridor for public utilities. If a waiver is requested, it is the developer's responsibility to provide a detailed narrative why an interparcel connection between developments could not be

achieved or provided or why such connection would not be beneficial to the County as required by this section.

D. Interparcel connecting streets shall be designed in consideration of the anticipated future traffic from undeveloped adjacent tracts based on the land use classifications of the Long Range Future Land Use Plan Map of the Comprehensive Plan.

E. The Thoroughfare Plan of the Comprehensive Plan indicates the necessity for major collector and arterial streets. The design and provision for the continuation of these streets shall be addressed in the design of all developments.

F. The street network proposed by a development shall be designed to provide an orderly access progression from local streets, to collector streets, to arterial streets. The planning and/or design of intersections to arterial or higher category roadways, shall only be allowed with the same or next category of street (major collector) unless it can be properly demonstrated that existing and/or projected traffic counts do not require a major collector or arterial category for the connecting road and no other alternative means of access is deemed feasible by the Director of Transportation.

G. When interparcel connections are made, residential local streets shall be laid out to discourage cut-through movements of vehicles, and to minimize or avoid four-way intersections.

H. Where interparcel connections are planned and required in developments where they are appropriately essential, traffic calming devices such as multi-way stop signs, roundabouts, choker islands, chicanes, etc. shall be provided as necessary and as required by the Director of Transportation.

601.02 Functional Classification of Streets: Functional classification is the process by which streets and highways are grouped together into systems according to the character of service they provide or are intended to provide. The following types of systems shall be utilized as guidelines to describe functional classifications within a street network, and shall not be utilized for the design or cross section of specific streets. Street design shall be based on traffic generation, existing and projected future traffic, adequate levels of service, and the Thoroughfare Plan of the Comprehensive Plan.

A. Local Street: A local street represents the lowest category of the functional classification system. Its sole function is to provide direct access to individual abutting parcels. Its traffic is local in nature and extent, rather than intracounty, intercounty, or regional. Generally, traffic volume should not exceed one thousand (1,000) vehicles per day (vpd).

B. Minor Collector Street: A minor collector street is designed primarily to serve the collection function for a group of local streets. Additionally, its purpose is to provide direct access to individual abutting parcels. It is designed to serve internal traffic movements within an area of the County, and connect with the arterial system. It is not meant to handle long through trips. Generally, traffic volume should range from one thousand one (1,001) vehicles per day (vpd) to seven thousand (7,000) vehicles per day (vpd).

C. Major Collector Street: A major collector street has a primary function to provide intra-neighborhood linkages and aggregate traffic, carrying it to the arterial system. It may also penetrate a neighborhood, distributing trips to ultimate destinations and, in rare instances, provide direct access to individual abutting parcels. Generally, traffic volume should range from seven thousand one (7,001) vehicles per day (vpd) to fifteen thousand (15,000) vehicles per day (vpd). This facility may carry local bus routes.

D. Arterial Street: An arterial street is designed to convey major movements of traffic within or through the County. It interconnects the principal traffic generators within the County and, in extremely rare instances, provides direct access to individual abutting parcels. There are three (3) types of arterial classifications:

1. Minor Arterial: A street designed for intracounty circulation and designation of neighborhood boundaries. It generally does not penetrate identifiable neighborhoods. Access to neighboring development is achieved by good design and the appropriate intersection spacing established in this section. Generally, traffic volume exceeds fifteen thousand (15,000) vehicles per day (vpd). The facility may carry local bus routes.

2. Parkway: A street designed primarily for through traffic and intracounty movement. On a parkway facility, service to the abutting land is subordinate to the provision of travel service to major traffic movements. Access to abutting land is achieved at designated intersections, rather than curb cuts, travelways and entrances. This facility is designed as a scenic urban linear park containing a wide grass median with landscape plantings and/or woodland conservation areas along each side. The landscape design is intended to be consistent along its route to define and enhance the visual integrity of the roadway. The facility also includes a sidewalk/shared use path for non-motorized traffic. Generally, traffic volume exceeds fifteen thousand (15,000) vehicles per day (vpd).

3. Principal Arterial: A street designed primarily for through traffic and intra and intercounty movement. On the principal arterial system, service to the abutting land is subordinate to the provision of travel service to major traffic movements. Access to the abutting land is minimized and is consolidated into service roads, shared entrances and appropriate designated intersections. Almost all fully and partially controlled access facilities are part of this functional class. Principal arterials also include a sidewalk/shared use path for non-motorized traffic. Generally, traffic volume exceeds fifteen thousand (15,000) vehicles per day (vpd). The facility may carry local bus routes.

E: Urban Street: Urban streets are streets that are designed to create safe movement for all users including transit, motor vehicles, bicycles, and pedestrians within urban centers of the County. All urban streets in urban centers shall be designed to accommodate the needs of users who want to access or pass through the community, neighborhood, surroundings or areas planned as urban centers. Urban centers refer to centers of commerce, centers of community, and urban mixed use (UMU) areas as shown on the Comprehensive Plan Long Range Land Use Map. Urban centers also refer to areas considered as a Town Center with Special Use Permit or are zoned Village (V). Typical elements that may make up an urban street include sidewalks, bicycle lanes, on-street parking areas, shared-use paths, transit stops, and pedestrian facilities including crosswalks, median islands, accessible access/ramps, and curb extensions all integrated to allow

easier and safe access balancing safety and convenience for everyone using the street. Any element of the urban street standards may be waived by the Director of Transportation with reasonable and acceptable justifications.

1. Through Boulevard: A Through Boulevard is the street type of highest multimodal capacity. It has higher speeds, medians, and street trees. It is intended to move traffic at a high level of service in urban centers.
2. Boulevard: A Boulevard has the highest density of destinations, activity, and mix of modes. Because of the close proximity of destinations, pedestrians and street activity are common. It is intended to have on-road bicyclists and pedestrian crossings; therefore traffic should move at a lower speed than on a Through Boulevard.
3. Avenue: An Avenue serves to connect Boulevards and Streets to Through Boulevards. It provides access to businesses and residential areas as a primary function.
4. Street: A Street connects to Avenues, Boulevards, or Through Boulevards and is intended for more residential urban areas with lower traffic volumes than the Avenue.
5. Private Side Street: A Private Side Street is intended for urban residential areas with on street parking and choker islands for landscaping. These streets will not be maintained by VDOT.
6. Private Alley: A Private Alley is intended to serve the rear of properties providing access to parking and service areas as well as to provide an easement for utilities. Private Alleys will not be maintained by VDOT.

601.03 Street Dedication: When a development abuts one side of a state maintained street(s), the developer shall be responsible for any right-of-way dedication, grading, surfacing, and drainage along such street(s) as may be deemed necessary by the Director of Transportation or VDOT and, to the extent commensurate with the additional traffic generated, to provide a safe entrance into the development. The development should also address the dedication of sufficient right-of-way and the construction of a half-section improvement of the street(s) for its entire frontage, to conform to the design standard for that street(s) as shown in the Thoroughfare Plan of the Comprehensive Plan, County approved functional plan, six-year secondary road plan as approved by the Board of County Supervisors, centerline studies, engineering plans, and the appropriate standards of this manual. The area dedicated for future roadway improvements may be used, provided it is not for the purpose of satisfying minimum requirements of the DCSM or Zoning Ordinance (i.e., parking storage, etc.). The placement of utilities within the dedicated area will be allowed when they are consistent with the ultimate roadway construction. If the dedicated area is used for any other purpose other than roadway construction, the developer shall escrow funds for the removal of any improvements not consistent with the planned roadway construction.

601.04 Street Access:

A. When the traffic generated from an entire development is projected to exceed two thousand five hundred (2,500) vehicles per day (vpd), the development shall access an existing state street in two locations. If approved by the Director of Transportation, one of the required connections may be made to a street constructed to state standards to be included in the State street system.

A VDOT permit shall be required prior to any construction within the state maintained right-of-way.

B. In situations where two (2) access points in accordance with the above cannot be physically made (due to restrictions in topography or sight distance, or due to limitations in state street frontage), a single connection may be allowed where specifically approved by the Director of Transportation, subject to the following conditions:

1. The single access shall be of a four (4) lane divided standard, extending at least three hundred (300) feet into the development for the first two thousand five hundred (2,500) vehicles per day (vpd) generated. For every additional five hundred (500) vehicle trips generated, or portion thereof, the four (4) lane divided street standard shall be extended an additional one hundred (100) feet.

2. Private entrances shall not access a proposed four (4) lane divided street when that street is designed in accordance with Section 601.04B(1). Internal streets and travelways in a development shall access an arterial street where a crossover is permitted.

C. All single-family detached dwelling lots, unless otherwise specified in the Zoning Ordinance, shall have frontage on and access to existing state maintained public streets or streets approved and bonded to be constructed to a standard acceptable for addition to the State street system. The amount of frontage shall be established in accordance with the regulations for the zoning district, as provisioned in the Zoning Ordinance.

D. Commercial, institutional, and industrial lots may be approved for recording without public street frontage, provided that lots have an access easement which meets the approval of the Director of Transportation. To assure maintenance of the access easement, an association of owners must be established prior to the approval of any plats or plans. Improvements within the access easement must be sufficient to accommodate the type and volume of traffic anticipated and constructed to the standards satisfactory to the Director of Transportation.

E. Single-family attached, multifamily, mobile home, commercial, and industrial development shall have access to a state maintained street. This access may be via private travelways, provided they meet the appropriate design standards in accordance with Details 650.06, 650.07, and 650.08 of this manual. An association must be established for the ownership and perpetual maintenance of travelways in a development. Travelways serving residential development shall not carry greater than one thousand (1,000) vehicles per day (vpd).

F. Travelways in single-family attached and multifamily developments, where the design traffic count exceeds one thousand (1,000) vehicles per day (vpd) shall be designed and constructed in accordance with Detail 650.07 of this manual. These streets do not provide on-street parking and are to be utilized only in developments where there is adequate off-street parking in separate parking bays, and no individual unit fronts directly on the street.

G. In a residential mobile home (RMH) development, streets with projected vehicle counts greater than four hundred twenty (420) vehicles per day (vpd) shall be designed and constructed to a standard acceptable for incorporation into the State street system. All streets in any RMH

shall be named and signed accordingly to include directional signs to the addresses as well as the units displaying legible address lettering. In addition, all streets shall have appropriate traffic control signs according to the MUTCD.

H. Privately-maintained travelways shall be platted such that all lot owners are assured perpetual right-of-access to a state maintained street. When permitted by the Zoning Ordinance, single-family lots approved for suburban cluster standards may be platted with frontage and access consisting of a pipestem driveway. In such cases, the development shall conform to the requirements for pipestem driveways in accordance with Section 602.16.1 of this manual.

I. In commercial, institutional and industrial lots or developments, adequate interparcel travelways shall be required to provide perpetual interparcel access for the movement of vehicles. An adequate easement shall be provided for the interparcel access. The recorded plat shall note the perpetual interparcel access as "privately owned and privately maintained by the lot owner(s)."

601.05 Street Intersections:

A. Existing and proposed crossovers planned or approved by the Director of Transportation and VDOT shall serve as the intersections for all development along existing and future divided highways.

B. The number of intersections of local streets with collector or arterial streets shall be held to a minimum to avoid hazard, delay, and preserve their integrity, and shall be coordinated with the crossover locations planned or approved by the Director of Transportation and VDOT for existing and future divided highways.

601.06 Street Extensions to the Property Line:

A. All streets shall be constructed to the property boundary with any adjoining properties if eligible to be accepted into the state secondary system, and shall terminate with an on-site temporary turnaround. However, off-site temporary turnarounds may be allowed if the developer can obtain temporary turnaround easements from the adjacent property owners. If said easements are provided, the developer shall escrow funds for the maintenance and removal of the temporary turnaround. The construction of the temporary turnaround shall conform to the pavement design of the street where they are located.

B. All planned interparcel connections shall be constructed to the subdivision or site boundary limit with adjoining properties. If a temporary turnaround is required onsite, the right of way for the turnaround shall be dedicated and all setback requirements referred from the right-of-way line or the temporary turnaround easement whichever is more restrictive. In the event that the interparcel connection is not constructed due to topographic or other physical constraints and/or a change in the needs of the community, the temporary turn around shall be converted to a permanent cul-de-sac acceptable to VDOT and the temporary easement converted to a permanent right-of-way.

C. If the aforementioned construction of streets or interparcel connection to the property line causes hardship to the developer, the Director of Transportation may allow the street construction to stop a distance from the property line, to be determined at the time of site development plan review.

D. The developer shall provide on-site temporary construction easements of sufficient width and the right-of-way dedication to accommodate the permanent turnaround in the event such planned interparcel connection will not be realized. The dedicated right-of-way area shall be vacated in the event the connection is made.

E. Escrow shall be obtained for the following:

1. Maintenance and removal of the temporary turnaround.
2. Future completion of the street to the property line.
3. Grading and stabilization of disturbed areas within the easement.

601.07 Service Drives:

A. The reverse frontage concept, which allows internal public street frontage, is encouraged such that no lot has direct ingress or egress along a major collector, minor arterial or primary arterial street. If this is not feasible, common driveways and interparcel connectors shall be utilized.

B. Development that cannot be served by common driveways and interparcel connectors shall have a service drive fronting on major collectors, minor arterials or primary arterials to prevent direct access to such streets. The service drive shall extend the full frontage of the development along such streets, tie into neighboring development as an interparcel connector, and provide limited access at the appropriate designated intersection. Service drive design and construction shall be in accordance with Detail 650.21 of this manual.

601.08 Street Curb and Gutter:

A. Curb and gutter shall be provided within subdivisions requiring urban street sections. This excludes rural residential zoning districts requiring a minimum lot size of one (1) acre and greater and in low impact developments (LID).

B. Any required improvements to existing state maintained streets, necessitated by development, shall provide curb and gutter and sidewalk/shared use paths if the adjoining properties meet the requirements for curb and gutter.

C. On privately-maintained travelways, curb and gutter contiguous to a fire hydrant shall be painted yellow, fifteen (15) feet to each side of the fire hydrant. This clear access area shall be marked as fire lane.

601.09 Street Lights:

- A. All roadway luminaires shall be installed, owned, and maintained by the supplying utility company, upon approval of the County.
- B. The developer shall pay for the cost of installation.
- C. On public roadways, the County shall assume the operation and maintenance costs of the luminaires once they are energized.
- D. Bonding for the cost of installation of roadway luminaires is required.
- E. Prior to the issuance of occupancy permits for lots in the vicinity of the roadway luminaires, the developer shall be required to submit a street lighting packet for the roadway lighting associated with the development to the Transportation Department. If the roadway lighting installations are delayed prior to occupancy, then a County-approved form, "Acknowledgment of Street Lights Installation" must be completed by the contract purchasers or property owners. The completed form and a paid receipt from the servicing power company shall be submitted to the site inspector before any bond reduction or bond release.
- F. As part of the construction of all new developments, each roadway luminaire and related wiring must be installed by the servicing utility company in a dedicated utility easement.
- G. Estimates for both roadway luminaire(s) and main line installations must be requested by the developer from the servicing utility company. Roadway luminaires and main line should be installed simultaneously.
- H. All roadway luminaire installations shall conform to VDOT specifications.
- I. The Street Lighting Branch or the servicing utility company will inform the developer of any modifications that may require compliance with current County and VDOT specifications and standards.
- J. The developer must submit a County-approved plan and bond sheet to the servicing utility company with roadway luminaire locations.
- K. Street lighting at the entrances of residential communities and commercial developments shall be the cobra head type fixtures or the expressway/interstate type fixtures. Decorative, area, or security lighting fixtures are acceptable as internal roadway lighting if the fixtures provide Type III light distribution.

602.00 TRANSPORTATION SYSTEMS - PLANNING AND DESIGN

602.01 Traffic Impact Analysis (TIA):

A. If a previous TIA was submitted at the rezoning or special use permit review stage, and the assumptions used in the TIA are consistent with the submitted site plan, no additional TIA will be required. However, if a previous TIA was not submitted in conjunction with the proposed development, a TIA shall be required for all developments, if the total generated additional trips meet or exceed one (1) or more of the following thresholds:

1. One hundred (100) or more total site generated peak hour trips or 1,200 trips per day as defined by the current edition of the Institute of Transportation Engineers (ITE) Trip Generation Manual or by a trip generation study acceptable to the County.
2. Anticipated new trip generation that uses any reserve roadway capacity to a point which changes the existing level of service on a roadway or each lane group at the intersection to "D" or below, based on the highway capacity manual thresholds.
3. The study area contains a segment of roadway and/or intersection considered unsafe. A location is considered unsafe when five (5) reportable accidents have occurred in the prior twelve (12) month period, or if it is on the County's annual list of most hazardous locations, provided by the Prince William County Police Department.
4. The Director of Transportation deems that it is prudent to require such assessment in the plan review process.

A TIA shall be prepared and submitted in accordance with Section 620.00 of this manual.

602.02 Transportation Demand Management (TDM)

602.02.1 Purpose

The purpose of these requirements is to provide a clear, concise set of guidelines for the area to be studied, the analysis and methodology to be employed, and recommendations to assess the effectiveness of a development proposal's Transportation Demand Management (TDM) strategies in reducing congestion while promoting alternative forms of transportation on the existing and future transportation network. In addition, they are designed to advise applicants what constitutes a comprehensive acceptable TDM plan for development proposals.

602.02.2 When A TDM Plan Is Required:

A. A TDM plan is required if the development proposal consists of Mixed-Use urban/suburban activity centers including a Neo-Traditional Development and/or Transit Oriented Development and the applicant is requesting trip generation credits or reductions in conjunction with the proposed development. These types of developments typically include higher intensities of land use than normally anticipated by the zoning ordinance. The TDM plan shall identify and mitigate the effects of these higher intensities.

B. A TDM plan shall be prepared and submitted in accordance with Section 630.00 of this manual.

C. A Traffic Impact Analysis (TIA) shall be required in conjunction with the submission of a TDM plan, either separately or as a part thereof. The TIA shall be prepared and submitted in accordance with Section 620.00 of this manual.

D. Strategies identified in the TDM Plan shall be measurable, monitorable, and enforceable through proffer.

E. Implementation of the TDM plan shall be designated in the plan.

602.03 Trip Generation Standards:

A. For residential development, the twenty-four (24) hour trip generation rate per dwelling unit shall be utilized in accordance with Table 6-1.

B. For commercial, industrial, institutional, and other development, the rates shown in the current edition of the Institute of Transportation Engineers' Reference Book, "Trip Generation Manual," shall be utilized.

C. All projected average daily trips (ADT), vehicles per day (VPD) or design traffic volumes shall be shown at each ingress/egress point and surrounding roadways.

602.04 Design Speed Standards:

A. Design speeds are used to determine the geometric design of streets to accommodate safe operation of vehicles to address sight distance requirements for all streets, travelways, access points, and commercial entrances.

B. The minimum design speed for new streets shall be based on the projected average daily trips (ADT) as shown in Table 6-2.

C. On existing streets, the design speed shall be determined by Table 6-3.

602.05 Sight Distance Standards:

A. Each new street shall be designed with horizontal and vertical curves meeting or exceeding the minimum stopping sight distance outlined in Table 6-4, and the minimum horizontal/intersection sight distance outlined in Table 6-5. Vertical curves shall have a minimum length of one hundred (100) feet except on cul-de-sac roll outs and intersections (Sec 650.34).

B. Sag vertical curves are required to provide not less than the sight distance shown in Table 6-4.

C. Sight distance for sag vertical curves shall be calculated for all ranges of algebraic difference in grade based on a headlight of two (2) feet and one degree upward divergence of the headlight beams. For horizontal sight distances, the location of the driver's eye should be set fourteen and a half (14.5) feet from the edge of outermost through lane of the roadway in question, as shown and specified in Detail 650.35 of this manual. (approved 8-4-15)

D. Table 6-4 assumes an eye height of three (3) feet, six (6) inches and a height of object (2) two feet.

E. Desirable sight distance values in Table 6-4 shall be used as the minimum values on all streets which carry greater than seven thousand (7,000) vehicles per day (vpd).

F. The K value in Table 6-4 is a coefficient by which the algebraic difference in grade may be multiplied to determine the length in feet of the vertical curve which will provide the minimum sight distance. K value shall be used to provide the minimum sight distance.

G. Table 6-5 assumes an eye height of three (3) feet, six (6) inches and a height of object of three (3) feet, six (6) inches.

H. The term "major street" in Table 6-5 refers to the street with the highest vehicles per day (vpd) of the two (2) intersecting roads.

I. All existing VDOT maintained streets are considered major streets. For divided streets where the median widths are greater than sixty (60) feet, each direction can be considered separately.

J. For more than four (4) lanes on a major street, or for large truck volumes on a minor street with twenty percent (20%) to twenty-five percent (25%) of the average daily trips (ADT), crossover or commercial entrance, use values in the latest edition of the "Policy on Geometric Design of Highways and Streets" published by AASHTO.

K. After each street has been designed in accordance with the criteria above, each intersection shall be checked for compliance with Table 6-5, and other intersection items such as standard landings (Detail 650.34), channelization, etc. Each connection to existing streets shall be checked to insure that the proper sight distances are achieved. The verification of these sight distances should be done graphically, checking both the horizontal and vertical alignments.

602.06 Median Crossovers:

Minimum crossover spacing along a divided street shall be provided in accordance with Table 6-6 or if the street is a state maintained road, the spacing shall be in accordance with VDOT Access Management Standards. The values for desirable distance between crossovers shown in the table shall be utilized in the design of all streets which will carry greater than seven thousand (7,000) vehicles per day (vpd).

602.07 Street Intersections:

A. Along arterial and major collector streets, the centerline separation of street intersections within the same lot, parcel, or development shall follow the minimum distance between crossovers as noted on Table 6-6 or if the street is a state maintained road, the spacing shall be in accordance with VDOT Access Management Standards. Along minor collector streets, the separation of accessing streets shall be three hundred (300) feet, unless proven to be undesirable by an approved intersection study.

B. A distance of at least two hundred (200) feet shall be maintained between centerlines of local street intersections.

C. All streets designed to carry traffic volume up to one thousand (1,000) vehicles per day (vpd) shall intersect at right angles for a minimum tangent distance of one hundred (100) feet. The tangent shall be measured from the face of curb or edge of pavement of the major street. For streets designed to carry traffic volumes exceeding one thousand (1,000) vehicles per day (vpd), a minimum tangent distance of two hundred (200) feet shall be required.

D. All shoulders of ditch type streets shall be paved at intersections in accordance with Detail 650.50 of this manual.

E. Along roadways classified as Category VI and above, left and right turn lanes shall be provided at all intersections, crossovers and/or entrances to developments. In addition, a signalized dual left turn lane shall be provided where existing or projected turning volume counts exceed three hundred (300) peak hour volumes (PHV) or design hourly volumes (DHV) or as otherwise warranted.

F. A right turn lane and taper shall be required at any intersection approach on a roadway that carries six thousand (6,000) or more vehicles per day (vpd).

G. All required standard deceleration or turn lanes and tapers shall be designed in accordance with VDOT and AASHTO standards (see Table 6-7).

H. When deemed necessary by a traffic impact analysis, the Director of Transportation and VDOT, a protected left turn lane shall be required at all street intersections where existing or projected turning volume count on either street exceeds three thousand (3,000) vehicles per day (vpd).

I. All curb returns shall have a minimum of thirty-five (35) feet radius for streets with curb and gutter. However, on industrial intersections and streets without curb and gutter, a minimum fifty (50) feet pavement return radius is required.

J. A standard CG-11 entrance shall be used for commercial and residential street intersections and commercial entrances. A minimum curb return radius of twenty-five (25) feet shall be required for commercial entrances. For street intersections, a thirty-five (35) foot curb return radius shall be required. Other entrances may also be used for access to VDOT maintained streets, with VDOT approval.

K. For all roadways classified as Category V and below, a distance of at least one hundred thirty (130) feet shall be maintained between the ends and beginnings (PTCR and PCCR) of curb returns of all commercial entrances (including single-family attached and multifamily). For all roadways classified as Category VI and above, a distance of at least two hundred eighty (280) feet shall be maintained between ends and beginnings (PTCR and PCCR) of curb returns of commercial entrances (including entrances for single-family attached and multifamily). The separation shall be the same between curb returns of an entrance and a roadway intersection.

L. Corner lots on street intersections, especially on curvilinear streets, shall be designed taking into consideration intersection sight distance easement requirements. Intersection sight distance easements should not occupy twenty-five percent (25%) or more of the total area of corner lots.

M. In general, driveway entrances on corner lots shall be located on minor streets or on the street where a stop sign is posted and outside of sight distance easements.

N. All parking spaces on single-family attached, multifamily, commercial, institutional and industrial developments should be designed such that their locations shall not obstruct the line of sight as graphically shown on Detail 650.35.

O. In general, standard intersection landings shall be required for all streets with lower traffic counts intersecting with streets carrying a higher volume of traffic in accordance with Detail 650.34 of this manual. The Director of Transportation or VDOT may approve alternative intersection landing locations if future traffic movements and intersection conditions justify such alternatives.

P. All entrances, except single-family detached driveways carrying less than one thousand (1,000) vehicles per day (vpd), which access a public street, shall incorporate a two percent (2%) landing for a minimum of twenty-five (25) feet from the existing edge of pavement.

Q. Entrances intended to carry over one thousand (1,000) vehicles per day (vpd) shall incorporate the use of standard landings in accordance with Detail 650.34 of this manual.

R. Pedestrian accessible ramps in accordance with IIM-LD-55 shall be provided at all curbed intersections, even when sidewalks and shared use paths are not present and shall be constructed in accordance with VDOT standards, or ADAAG (American with Disability Act Accessibility Guidelines) whichever is more restrictive.

S. A divided or channelized entrance will be provided for any entrance projected to carry 5,000 or more vehicles per day (vpd) in commercial, office or industrial developments. To enhance development aesthetics, the median shall be landscaped. Entrances to residential subdivisions that have medians shall also be landscaped.

T. All vehicles that are permitted to be parked or stored on residential properties on one (1) acre or less shall be parked or stored only on areas that are improved. Such parking or storage areas and similarly improved driveways shall not occupy more than thirty-five (35) percent of or seven hundred and twenty (720) square feet of the minimum required front yard, whichever is greater. In the case of pipestem lots, areas that are contained within the ingress and egress easement shall

not be included when calculating the coverage of the front yard by parking areas and driveways. This maximum coverage requirement may be modified as a part of the consideration of a modified dwelling unit type as indicated in the Zoning Ordinance.

602.08 Street Cul-de-sacs:

A. A cul-de-sac serving a residential development shall be designed to a length that will carry a maximum of two hundred fifty (250) vehicles per day (vpd). The minimum pavement radius of the cul-de-sac shall be forty-five (45) feet to either the face of the curb for urban streets or the edge of the pavement for rural streets.

B. In the case where a residential cul-de-sac street intersects with a street presently carrying, or projected to carry, greater than three thousand (3,000) vehicles per day (vpd), the Director of Transportation may require a cul-de-sac radius of fifty (50) feet.

C. A cul-de-sac serving a commercial and industrial development shall be designed to a maximum length of one thousand (1,000) feet. The minimum pavement radius of the cul-de-sac shall be fifty (50) feet to the face of curb or edge of pavement.

D. For offset cul-de-sacs where the minimum required radius is fifty (50) feet, the layout of the offset segment as shown in Details 650.23, 650.24, 650.28 and 650.29 should be considered in the design.

E. On the circular segment of a public street cul-de-sac, only one entrance (CG-11) to a single-family attached or multifamily development shall be permitted. The entrance shall align at one hundred eighty (180) degrees with the centerline of the public street. If feasible, three (3) entrances shall be allowed for commercial and industrial developments, provided their centerlines align at ninety (90) degrees to each other.

602.09 Street Grade and Layout:

A. The minimum grade for streets with curb and gutter shall be five-tenths of a percent (0.5%). The maximum street grade shall be as specified in the standards for each typical section. The minimum grade for streets without curb and gutter shall be one percent (1%).

B. The maximum centerline grade at the cul-de-sac shall not exceed five percent (5%). Any slope within the cul-de-sac pavement area shall not exceed five percent (5%). The cross slope of the street leading to the cul-de-sac shall be a minimum of two percent (2%).

C. Design of reverse and compound centerline curves on roadways functionally classified as Category VI and above, shall conform to minimum standard requirements of AASHTO-Policy on Geometric Design of Highways and Streets.

D. Except as provided in Section 601.07 single family residential lots shall not access arterials or major collector streets.

E. Loop or through roads shall have a standard typical cross section through their entire length

F. Lengths of horizontal centerline curves shall be in accordance with VDOT standards. The minimum allowed arc length shall not be less than one hundred (100) feet.

G. Sharp centerline curves such as ninety (90) degree bends shall be avoided in the design of roadways. If unavoidable, the centerline radius shall be increased to the extent possible to achieve a roadway cross section that can accommodate two-way traffic of emergency vehicles with consideration of parallel parking along it.

H. Along roadways classified as Category VI and above, the design of intersections on horizontal curves should generally be avoided.

602.10 Street Pavement Design:

A. The required thickness of the subbase, base course, and top or surface course shall be in accordance with the street standard in Detail 650.01 of this manual. CBR tests are required for streets within single family detached, single family attached and condominium developments. CBR tests are not required for private streets within multi-family, commercial, office, industrial or institutional developments. Subbase and/or base thickness is based on a subgrade CBR value of ten (10).

B. Final pavement design shall be determined after a CBR test is run to determine the true support values of the various soils in the subgrade. A representative from the Department of Transportation shall be present to verify the locations and minimum numbers of CBR tests required at the time samples are acquired from the subgrade. With the prior approval of the Director of Transportation, instead of a representative being present at the time of sample taking, a licensed engineer may certify that the samples tested were acquired from the same locations as indicated on the test results.

C. CBR test results shall be submitted in a form approved by the Director of Transportation and certified by a licensed engineer.

D. CBR values less than ten (10) shall require redesign by the Vaswani method.

E. All pavement designs for streets with traffic volume exceeding one thousand (1,000) vehicles per day (vpd) shall provide 21B, Type I aggregate as subbase or base material. This will also necessitate consideration of underdrains in the design.

602.11 Alternate Pavement Design:

When using alternate equivalent pavement design as a result of the CBR tests referenced in Section 602.10 of this manual, the following minimum and maximum thickness of layers shall apply:

A. Six (6) inches shall be the minimum thickness of the aggregate layer used as the base in a one- or two-layer system.

B. Four (4) inches shall be the minimum thickness of the aggregate layer used as the subbase.

- C. The minimum thickness of the bituminous concrete base layer for BM-25.0A shall be three (3) inches.
- D. One and one-half (1-1/2) inches shall be the minimum thickness of the bituminous concrete surface lift (SM-9.5A or SM-9.5D) used on top of the bituminous concrete base layer (BM-25.0A) or binder (IM-19.0A).
- E. Two (2) inches shall be the minimum thickness of the bituminous concrete surface layer (SM-9.5A or SM-9.5D) used on top of aggregate material (treated or untreated).
- F. Six (6) inches shall be the minimum thickness of the stabilized soil layer (cement, lime, etc.).
- G. Two (2) inches shall be the maximum thickness of the bituminous concrete surface (SM-9.5A or SM-9.5D) for one lift.
- H. For staged construction, two and one-half (2-1/2) inches shall be the maximum thickness of the bituminous concrete surface (SM-9.5A or SM-9.5D). The thickness of each lift shall be of one and one quarter (1-1/4) inches.
- I. If staged construction is performed, a four (4) foot radius area, measured from the center of the manhole cover around protruding utility manholes, shall be paved with leveling asphalt concrete surface mix (SM-9.5A) to provide a relatively smooth riding surface. In addition, the asphalt concrete paved peripheries shall be painted with twelve (12) inch wide white colored paint acceptable to County inspectors. The maximum exposure limit for staged construction shall be two (2) years, unless it is extended by the Director of Transportation.
- J. One-half (1/2) inch integrals shall be utilized for aggregate materials (i.e., eight (8) inches or eight and one-half (8-1/2) inches, but not eight and one quarter (8 1/4) inches
- K. Eight (8) inches shall be the maximum thickness of the aggregate base or subbase material. If eight (8) inches is exceeded, a bituminous material (BM-25.0A) shall be substituted.
- L. When the bituminous concrete base is equal to or exceeds three (3) inches, the underlying material shall be considered subbase.
- M. As long as the total bituminous concrete thickness does not exceed four (4) inches, the first eight (8) inches of the underlying material may use the thickness equivalency value for the base. The remaining depth shall use the subbase value.
- N. Six (6) inches shall be the maximum thickness of the aggregate layer used over soil cement or cement treatment aggregate.
- O. Six (6) inches shall be the minimum thickness of cement treated aggregate placed directly on untreated subgrade.

602.12 Paved Ditches, Underdrains and Guardrails:

- A. Paved ditches, underdrains and guardrails shall be designed and constructed in accordance with VDOT specifications.
- B. A standard VDOT combination underdrain UD-1 and/or UD-2 shall be provided at all low points of street vertical curves.
- C. UD-1 must be used with high water table. UD-2 must be used with raised grass median.
- D. UD-4 shall be provided in the pavement design when 21-B aggregate material is used.
- E. A guardrail shall be required when fill exceeds ten (10) feet in height and there is not a recoverable slope.
- F. In general, design and locations of guardrails will necessitate the need of additional right-of-way especially in fill conditions. In the event that guardrail has to be located outside the standard ROW width, additional right-of-way dedication must be provided to accommodate the guardrail.
- G. Guardrails shown on the approved plan shall be installed after the asphalt base course of the roadways is in place and/or prior to the issuance of occupancy permit for uses within the development.

602.13 Street Lights:

- A. Utility easements shall be provided on the utility plats along the frontage of all lots in a residential development. The developer will be responsible for granting utility easements and ensuring that all bonded roadway luminaires are installed.
- B. Roadway luminaire poles must be either breakaway type or be located outside the right-of-way or the minimum required clear zone, whichever is greater. Roadway luminaires and arm brackets shall not overhang the travel way/through lane by more than one (1) foot. On sections with turn lanes, the luminaire and arm bracket may overhang the entire turn lane but shall not extend over the travel way/through lane by more than one (1) foot. .
- C. In single-family detached residential developments, a minimum of two (2) luminaires shall be provided at all entrances to the development. A minimum of two (2) luminaires shall be provided at all street intersections where the minor street carries greater than four hundred (400) vehicles per day (vpd). One (1) luminaire shall be provided at all public and private cul-de-sacs, stub-outs, and dead ends, including temporary cul-de-sacs.
- D. Intersection luminaires must overhang the approach lanes of the street carrying the larger volume of traffic. The overhang should be at ninety (90) degrees from the edge of pavement.

E. In single-family attached and multifamily developments, a minimum of two (2) luminaires shall be provided at all primary entrances to each section of the development accessing onto the main public roadway and all secondary entrances, which carry greater than four hundred (400) vehicles per day (vpd). One (1) luminaire shall be provided at all public and private cul-de-sacs, stub-outs, and dead ends, including temporary cul-de-sacs.

F. Two (2) roadway luminaires shall be provided at all entrances of commercial and industrial developments that carry greater than four hundred (400) vehicles per day (vpd). One (1) roadway luminaire shall be provided at all primary and secondary entrances of commercial and industrial developments that carry greater than two hundred (200) vehicles per day (vpd).

602.14 Privately Maintained Travelways and Parking Areas:

A. Privately maintained travelways, where permitted, with traffic counts up to one thousand (1,000) vehicles per day (vpd) shall be designed and constructed in accordance with Detail 650.06 of this manual.

B. Main travelways carrying greater than six hundred (600) vehicles per day (vpd) shall not have direct access from parking spaces, except travelways serving parking bays in office, commercial and industrial developments, and unless otherwise permitted by the Director of Transportation.

C. Entrances and travelways into commercial and industrial development may carry greater than one thousand (1,000) vehicles per day (vpd), provided that these entrances and travelways are designed with the appropriate pavement width, pavement categories, channelization, and controlled access based on the projected traffic counts and movements.

D. Travelways and parking areas permitted in industrial, institutional, office, commercial, multifamily, and single-family attached developments shall be designed and constructed in accordance with Detail 650.06 of this manual.

E. In planned mixed residential districts such as PMR, RPC and PMD, residential mobile homes (RMH), and single-family attached developments where the standard private travelway (TS-1) is allowed, the required eight (8) feet wide separation on both sides of the travelway shall be provided throughout the street layout, including along corner lots. The separation width will be measured eight (8) feet from the face of the curb to the property line. All other elements of the travelway such as sidewalk and utility or grass strip shall also be provided.

F. Industrial, institutional, office, commercial, multifamily, and single-family attached developments which are located in the Development Areas (except semi-rural residential areas), as designated by the Comprehensive Plan, are required to have curb and/or gutter along all travelways and paved parking areas. Additionally, this requirement applies to developments that access state roadways that have and/or are planned to have curb and gutter. Curb and gutter will not be required if the area drains to a low impact development (LID) that applies integrated management practices (IMP). Curb cuts are also acceptable that drain to a LID.

G. Residential development in the Rural Areas as designated by the Comprehensive Plan may have privately-maintained streets designed and constructed in accordance with Detail 650.02 of this manual and VDOT requirements.

H. A cul-de-sac or appropriate turnaround shall be provided at the end of all privately-maintained travelways. Otherwise, travelways must interconnect within the development to provide for adequate emergency vehicular access. If a turnaround is provided, it shall be designed to allow for the safe movement of emergency vehicles, service trucks, and school buses. Any design variations of the turnaround not in accordance with Detail 650.31 shall require prior approval by the Director of Transportation.

I. Short parking courts, bays or cul-de-sacs shall be designed with turnarounds that will accommodate car turning characteristics.

J. On gated communities, access control gates and queuing areas when provided on privately-maintained travelways shall be designed, installed, and located acceptable to the Director of Transportation and Fire Marshal's Office. Access control gates and all appurtenances, facilities and equipment shall not be allowed on public right-of-way. An adequate vehicle queuing area as determined by the Director of Transportation must be provided to prevent spill over or blockage of public roadways. When provided, a separate pedestrian gate exclusive of the vehicle movement area may also be provided.

602.15 Privately Maintained Travelway Pavement Design:

A. Association/owner maintained travelways for commercial development shall be designed in accordance with the following:

1. Owner or association maintained travelways and parking areas for commercial development shall have at a minimum a six (6) inch base and a one and one-half (1-1/2) inch bituminous surface to insure a dustless surface.
2. CBR tests shall not be required. The methods and materials used in the construction of these facilities shall conform to the current VDOT road and bridge specifications, or the standards specified in this manual.

B. Association/owner maintained travelways for residential development shall be designed in accordance with the following:

1. Parking areas shall have, at a minimum, a six (6) inch base and two (2) inch bituminous surface. The curb and gutter shall have a minimum of four (4) inches aggregate base material, which will extend six (6) inches behind the back of the curb.
2. Privately-maintained travelways shall have pavement sections that conform to Detail 650.06 of this manual.

3. If subgrade CBR is ten (10) or greater, no additional subbase shall be required. Alternate pavement design may be substituted with the approval of the Director of Transportation, when designed by the Vaswani method.

4. A privately maintained travelway serving a multifamily development that intersects with a state maintained street shall have a standard landing in accordance with Detail 650.34 of this manual.

602.16 Pipestem Driveways and Alleyways:

602.16.1 Pipestem Driveways:

A. When permitted by the Zoning Ordinance, the lots served by pipestem driveways shall be limited to twenty percent (20%) of all lots within a subdivision.

B. The length of the pipestem driveway shall not exceed a distance of three hundred fifty (350) feet where the required lot size is ten thousand (10,000) square feet or less, and shall not exceed four hundred (400) feet where the required lot size is greater than ten thousand (10,000) square feet but less than fifteen thousand (15,000) square feet. Longer driveway lengths may be permitted where the lot size exceeds the minimum requirements of the Zoning Ordinance but must be designed with an adequate turnaround in accordance with Details 650.30 and 650.31.

C. When allowed by the Zoning Ordinance and unless specifically waived by the Director of Transportation, a pipestem driveway shall serve a maximum of five (5) lots, and shall be designed in accordance with Detail 650.32 of this manual.

D. When more than one (1) pipestem driveway is proposed on the same side of an existing street or street to be dedicated to public use, the centerlines of the pipestem driveways shall be spaced at least two (2) lot widths apart, but in no case less than one hundred forty (140) feet. For acceptable typical pipestem layouts, refer to Detail 650.33A of this manual.

E. Ingress and egress easements shall be provided for a pipestem driveway. An easement for a pipestem driveway serving one (1) lot shall be a minimum of eighteen (18) feet in width, and for a pipestem driveway serving two (2) or more lots, the easement shall be forty (40) feet in width. A street name may be required for such easements as deemed necessary by the Director of Transportation. The paved portion of the pipestem driveway shall be ten (10) feet in width when serving one (1) lot, and eighteen (18) feet in width when serving two (2) or more lots.

F. Lots with public street frontage and contiguous to a pipestem driveway shall not contain a structure within fifteen (15) feet of the access easement line.

G. When a pipestem driveway is proposed opposite an existing or proposed street, its centerline shall be either aligned with the centerline of the opposing street, or offset from its centerline by at least two hundred (200) feet.

H. Lots served by a pipestem driveway shall have a combined frontage width not to exceed the width of the access and maintenance easement for that driveway.

- I. The slope of a pipestem driveway shall not exceed eight percent (8%). A landing sloped at two percent (2%) shall be incorporated into a pipestem driveway for the first twenty (20) feet. Landings shall be constructed in accordance with Detail 650.32 of this manual.
- J. Each cluster pipestem lot shall have a paved driveway large enough to accommodate three (3) vehicles exclusive of the garage. The required parking shall not be located within the pipestem portion and shall be located outside of the ingress/egress easement.
- K. Mailboxes shall be located adjacent to a public street according to a coordinated standard, to serve all lots on a pipestem driveway.
- L. Suitable turnarounds shall be provided at the end of a pipestem driveway serving three or more lots in accordance with Details 650.30 and 650.31 of this manual. When the length of a pipestem driveway exceeds 250' measured from the edge of pavement of the road to the first edge of the last driveway entrance; a turnaround that could accommodate an emergency vehicle used by the Fire Marshal's Office should be provided. The design should conform to Detail 650.31. Pipestem driveways that are 100' or less in length shall be provided with turnarounds conforming to Detail 650.30 and for 100'-250' long driveways, Geometric Shape #4 that can accommodate 30' long SU truck of Detail 650.31 respectively. Turnaround shall not be allowed between dwelling units or lots. The turnaround slope shall not exceed five percent (5%).
- M. All pipestem driveways shall have a minimum centerline radius of sixty (60) feet.
- N. To insure that appropriate drainage is achieved, grading for the pipestem driveways shall include cuts and fills defining the ditch lines and the locations and size of driveway culverts.
- O. Pipestem driveway elements shall include two (2) feet wide gravel shoulders with well-prepared, compacted subgrade, and sloped eight percent (8%) grade away from the edge of pavement. Where appropriate, well-defined swales or side ditches shall be provided. Alternative shoulder treatment may be approved by the Director of Transportation where positive drainage can be demonstrated.
- P. On ditch section pipestem driveways, driveway entrances for the lots shall be designed in accordance with Detail 650.45 (DE-4) of this manual.
- Q. The typical cross section for a pipestem shall have a normal crown with two and eight-hundredths percent (2.08%) slopes. Straight slope with two and eight-hundredths percent (2.08%) maximum can be considered, provided that the drainage design shall insure positive drainage away from the pavement structure.
- R. The pavement design for pipestem driveways shall be the same as of the adjacent street where they are connected. Five (5) inches of plain Portland cement concrete is acceptable as an alternative subject to the following:
1. Class of concrete shall be Class A-3 in accordance with VDOT standards.

2. The methods of construction such as forming, crack controls, jointing, finishing, curing, and protection of concrete pavement from the initial traffic should be in accordance with VDOT road and bridge specifications.
3. Spacing of transverse control joints shall be a maximum of fifteen (15) feet. Longitudinal control joints shall be provided in all pavement sections wider than twelve (12) feet.
4. Drainage or storm water runoff shall not be allowed to flow longitudinally within the paved portion of the pipestem driveway. Positive drainage shall be maintained. Storm runoff shall be channeled away from the pavement, through the side ditches or gutter pan, if any.

S. A centerline profile for the pipestems serving two (2) or more lots shall be provided to ensure appropriate landings; grade ties and appropriate drainage design are achieved.

T. Grading plans for all pipestem driveways serving two (2) or more lots shall be provided and included on construction plans, together with the appropriate turnarounds and necessary easements.

U. Design configuration of pipestem layouts shall be in accordance with Detail 650.33A of this manual.

V. The methods and materials used in the construction of pipestem driveways shall conform to the current VDOT road and bridge specifications unless specified herein.

W. Entrance/intersection and vertical sight distance shall be verified and maintenance easement required when necessary on all pipestem driveway entrances.

602.16.2 Alleyways in Planned Districts: Alleyways shall be discouraged in proposed residential developments where street networks are planned and designed to be publicly maintained. However, they may be allowed in town centers subject to Special Use Permit (SUP) Conditions and in any PMD or PMR Zoning Districts.

A. Alleyways shall be a minimum of twelve feet (12') wide if one-way and twenty- two feet (22') wide if two-way, measured from face of curb to face of curb. Parking along alleyways shall not be allowed and traffic control signs ("No Parking," "Stop" signs etc.) shall be required.

B. Ingress/egress and maintenance easements shall be required for all alleyways. The easement width for a one-way alley shall be eighteen feet (18') and for a two-way alley shall be twenty-eight feet (28'). Additional easement width will be required at the intersections to accommodate signage and ensure clear intersection sight distance

C. Standard maintenance note for alleyways will require the notification of owners of lots being served by the street of their obligation for the maintenance of the road.

D. Geometric, vertical and horizontal design of alleyways shall be in conformance with the requirements of Section 602.15 of the DCSM unless deemed not necessary by the Director of Transportation.

E. The length of the driveway accessing an alleyway shall be eighteen feet (18') measured from the edge of pavement (EP) or face of curb (FC) of the alleyway to the edge of the garage.

F. Dead-end alleyways are generally discouraged, but if allowed due to special circumstances, a standard turnaround that will accommodate a forty foot (40') long fire truck or emergency vehicle shall be provided if required by the Fire Marshal.

G. If parking is not available in the main roadway fronting single family detached lots served by rear alleyways, three (3) on-site parking spaces, exclusive of the garage, shall be provided for each lot.

H. Adequate intersection sight distance shall be required and verified on alleyway intersections. On-street parking shall not be allowed on street intersection approaches where lines of sights are verified to achieve clear adequate sight distance.

I. Entrances to and exits from alleyways should be designed with turning radii adequate to accommodate the size and type of vehicle expected to access the alleyways. Alleyways will require the review and approval of the Fire Marshal if it is designated as a fire access road.

602.17 Common Driveways for Two Lots:

A. Where permitted by the Director of Transportation and by the Zoning Ordinance in large lot subdivisions, two (2) lots may be served by a common driveway. An adequate access easement at least forty (40) feet wide shall be provided.

B. The width of the common driveway shall be eighteen (18) feet.

602.18 Sidewalks/Shared Use Paths:

A. Sidewalks or shared use paths shall be required along all proposed streets and where improvements to such streets are necessitated by development.

B. In general, and to the extent set forth in subsection A above, sidewalks or shared use paths shall be required within the street right-of-way of any development or subdivision with curb and gutter (urban section) streets. Sidewalks shall be provided as shown on the standard typical street section and as determined in the plan approval process. In some cases, pedestrian trails/shared use paths may be located outside the street right-of-way, in lieu of the standard sidewalk required and, in this case, shall be maintained by the developer and/or homeowners association.

C. Where required by VDOT or designated in the Comprehensive Plan, Class I and Class II bike trails should be provided. The design for Class I and Class II bike trails shall conform to the requirements and standards of VDOT and AASHTO.

D. Sidewalks or shared use paths shall interconnect with those of surrounding development to ensure safe and direct access to schools.

E. No occupancy permit shall be issued until all sidewalks and/or shared use paths in the general area of the units scheduled for occupancy, have been constructed, inspected, and approved.

F. Trails/shared use paths shall be designed and constructed in accordance with the Details 650.36, 650.37, 650.38, 650.39 or 650.40 of this manual.

G. A sidewalk or trail/shared use path system shall be provided in an R-4-and R-2 cluster development in accordance with Section 32-300.61 of the Zoning Ordinance.

H. Substitution of sidewalks for trails/shared use paths or vice versa in cluster development shall only be approved in instances where safe and sufficient pedestrian circulation is provided between recreation facilities, passive open space areas, and other off-site amenities likely to be used by residents.

I. In multifamily and single-family attached development, sidewalk and shared use path systems shall be designed to be continuous and connect to a public street. Sidewalks shall be provided on both sides of the privately-maintained travelways in accordance with Detail 650.06 of this manual.

J. A profile of the proposed trail/shared use path construction shall be included in the plans. Typical cross sections shall be provided for all critical (e.g., deep cuts, change in alignment, etc.) points along the length of the trail/shared use path.

602.19 Sidewalk/Shared Use Path Maintenance:

A. When sidewalks/shared use paths located within the right-of-way are not eligible for VDOT acceptance and maintenance pursuant to the Subdivision Street Requirements Manual, a standard tri-party maintenance agreement, developed by the County, shall be executed among the County, the developer, and the homeowners association prior to the final subdivision or site plan approval. This agreement shall be deemed a part of the final subdivision or site plan. The Director of Transportation is hereby authorized to endorse the agreements and amendments described in this section on behalf of the Board of County Supervisors as the County's agent.

B. If a homeowners association is not established at the time of plan approval, the developer shall enter into a written agreement, developed by the County, under which the developer will assume full responsibility to maintain the sidewalks/shared use paths. When a homeowners association is created and enters into a written amendment to the agreement signed by the County and developer, which amendment is signed by the homeowners association, the County, and the developer, under which the homeowners association assumed maintenance responsibility for the sidewalks/shared use paths, the developer will be relieved of the maintenance responsibility undertaken by the homeowners association. This agreement, and all amendments to the agreement, whenever executed, shall be deemed part of the final approved subdivision or site plan.

602.20 Trail/Shared Use Path Safety Considerations:

- A. The safety of pedestrians and bicyclists shall be a prime consideration in trail/shared use path design. Shared use paths shall be constructed adjacent to the street curb or pavement. Shared use paths which are located adjacent to streets with speed limits exceeding twenty-five (25) miles per hour and have slopes greater than six percent (6%), may require special safety measures, such as the installation of barriers or other safety devices, or an increase in the distance between the shared use path and the street.
- B. Standard signing and markings, as specified by the Department of Parks and Recreation or the Manual of Uniform Traffic Control Devices (MUTCD), shall be included in the design and construction of the trail/shared use path.
- C. The design engineer shall address stopping and intersection sight distances at all trail/shared use path intersections, curves and, particularly, where steep grades are proposed at trail/shared use path/street intersections.
- D. Standard curb ramps for persons with mobility impairments shall be provided at all trail/shared use path curb crossings to allow continuity of trail/shared use path use by pedestrians and bicyclists. Curb depressions shall be equal to the trail/shared use path slope and shall not be steeper than twelve-to-one (12:1).
- E. Barricades shall be provided at all trail access locations to prevent unauthorized vehicular access. The barricades shall have locking/unlocking devices to permit access by authorized maintenance and emergency vehicles. Barricade designs are subject to approval by the Director of Transportation.

602.21 Trail/Shared Use Path Easements:

- A. Where the typical road section does not include sufficient width to meet the minimum required trail/shared use path, additional area shall be placed in an easement adjacent to the street right-of-way and dedicated to the County in the form of a public trail/shared use path easement.
- B. Trail easements shall have minimum widths in accordance with Details 650.37, 650.38, 650.39 and 650.40 of this manual. Additional temporary grading easements may also be required, depending on the slopes.
- C. Where trail design requires the construction of a retaining wall, the wall shall be located completely within the easement. This may require the expansion of the easement to accommodate the wall.
- D. Where trail easements are proposed to encroach in utility easement areas, appropriate coordination must be accomplished with, and approval obtained from, the affected utility owner.

602.22 Trail/Shared Use Path Grade and Drainage:

A. A minimum grade of one percent (1%) shall be required for trails/shared use paths, except in sags where proper drainage is provided by the cross slope. A slope of one percent (1%) to six percent (6%) is generally required for all trails/shared use paths. If, due to topography, this requirement cannot be met, then a slope of six percent (6%) to ten percent (10%) may be allowed with the approval of the Director of Transportation.

B. Cross slope shall be a minimum of one quarter (1/4) inch per foot width of trail/shared use path with a maximum of a half (1/2) inch per foot width of trail. Where slopes exceed these standards, the design engineer shall submit a special design, including use and safety considerations, for review and approval by the Director of Transportation.

C. Trail/shared use path centerline turning radii shall be in accordance with Detail 650.36 of this manual; however, with the approval of the Director of Transportation, the actual design may be based upon the expected use and site conditions.

D. Drainage design for trails/shared use paths outside the right-of-way shall be designed in accordance with the storm drainage requirements in Section 700.00 of this manual. Shared use paths within VDOT right-of-way shall meet the VDOT standards for drainage.

E. As a general guide, where a trail/shared use path is cut into a hillside, a swale shall be placed along the high side of the path to prevent sheet flow across its width. Appropriate drainage improvements shall be provided along longitudinal slopes exceeding six percent (6%).

602.23 Trail/Shared Use Path Bridges:

A. Where a crossing of a watercourse is required, a pedestrian bridge or a fair weather crossing shall be required.

B. Pedestrian bridges shall be designed using a prefabricated standardized steel truss and with pressure treated timber decking. Bridge specifications may be obtained from the Department of Parks and Recreation. Special designs shall be reviewed for locations requiring spans greater than fifty (50) feet or other special design considerations.

C. If a bridge is required for trails/shared use paths greater than 6 feet in width, the bridge must be a minimum of 1 foot wider on each side of the center line of the trail/shared use path (total of 2 feet).

602.24 Trail/Shared Use Path Steps:

A. Trail/shared use path steps shall be provided only in instances where requested by the Director of Transportation.

B. Trail/shared use path steps shall be concrete and construction shall be in conformance with VDOT standards.

602.25 Street Planting:

A. If required by Section 800.00 of this manual, street planting shall be provided in the right-of-way in accordance with VDOT's current Guidelines for Planting Along Virginia's Roadways.

B. When landscaping located within the right-of-way is not eligible for VDOT acceptance and maintenance, a standard tri-party maintenance agreement shall be executed among the County, the developer, and the homeowners association prior to the final subdivision or site plan approval. The Director of Transportation is hereby authorized by the Board of County Supervisors to sign all agreements described in this section on behalf of the County as its agent. Such agreements shall be deemed a part of the approved final subdivision or site plan.

C. If a homeowners association is not established at the time of plan approval, the developer shall be responsible for maintaining the landscaping located within the right-of-way until such time that the homeowners association is established and enters into a written amendment to the landscaping agreement, signed by all parties, under which the homeowners association accepts landscaping maintenance responsibility from the developer. This agreement, along with any amendments, whenever executed, shall be deemed part of the final subdivision or site plan.

603.00 TRANSPORTATION SYSTEMS - SUBMISSION REQUIREMENTS

603.01 Traffic Impact Analysis: A traffic impact analysis (TIA) required by Section 602.01 shall be submitted as part of the site development plan application and shall conform to the Prince William County traffic impact analysis requirements in accordance with Section 620.00 of this manual.

603.02 Plans:

A. Plans for public streets and privately-maintained travelways, access aisles, and parking areas shall include either a typical section or a reference to a specific standard and pavement design. The plans shall include the items listed in this section and the design standards of Section 602.00 of this manual.

B. The plans shall indicate street construction for the full frontage of all lots. All street construction, including sidewalks, shall be within the dedicated street right-of-way. Grading or filling may be done in adjoining easements.

C. Plans for street construction within the one hundred (100) year floodplain, shall be in accordance with Section 700.00 of this manual.

D. All site plan names are subject to approval by the Department of Information Technology and shall comply with the following:

1. Duplication or close approximation of names already in use shall not be permitted.
2. The name of the recorded subdivision shall apply.

3. Names shall not be changed subsequent to approval of the name during site development plan review.

E. A profile of proposed sidewalk/shared use path construction shall be included in the plans.

F. A sign and pavement marking plan shall be submitted for all development that will generate greater than five hundred (500) vehicles per day. The plan shall utilize the latest requirements in the MUTCD and VA Supplement to the MUTCD for Streets and Highways.

603.03 Topographic Information and Grading Plans for Streets:

A. Existing topography, and all proposed grading for streets, shall be shown at two (2) foot intervals.

B. Plans which propose coordinated street and site grading shall indicate house or building locations in accordance with grading requirements in Section 700.00 of this manual.

C. Plans limited to street design shall not indicate grading beyond twenty-five (25) feet from the right-of-way line. However, if grading beyond twenty-five (25) feet from the right-of-way line is deemed necessary, a grading permit shall be required.

D. The site development plan shall provide a note that a smooth grade shall be maintained from the centerline of the existing street to the proposed curb and gutter, to preclude the forming of false gutters and/or the ponding of water on the roadway.

603.04 Street Station Points and Centerline Curve Information:

A. Station points shall be indicated on the plans for the following:

1. Every one hundred (100) feet on the street centerline.
2. Points of curvature (PC's), points of intersection (PI's), and points of tangents (PT's).
3. Centerline intersections.
4. Subdivision or section limits.
5. Turnaround radius points.

B. Center line curve information shall be provided on the plan by:

1. Labeling of all proposed roadway centerline curves.
2. Providing centerline curve data (delta, tangent, length of curve, chord etc.).

603.05 Street Sight Distances:

- A. Sight distances for all horizontal curves, and at all intersections, shall be shown on the plans.
- B. Sight distances and design “K” values for all vertical curves shall be shown on the profile sheets.
- C. The profile sheets must indicate the sight distances of existing streets for a minimum distance of three hundred fifty (350) feet or the applicable sight distance, whichever is greater in each direction.
- D. Adequate horizontal sight distance easements shall be indicated on the plans. The easements shall be located outside the right-of-way to assure that the line of sight will be kept clear of any obstructions that may diminish the available sight distance. An appropriate note to identify the maintenance responsibility of the sight distance easement shall be shown on the plans and plats.

603.06 Building Restriction Line Profiles for Streets:

- A. A profile along the building restriction line shall be included in the plans.
- B. Where there is no building restriction line, a profile of twenty-five (25) feet from the right-of-way line shall be included in the plans. Any profile distance greater than twenty-five (25) feet shall require approval by the Director of Transportation.
- C. A building restriction line profile shall be extended three hundred (300) feet beyond the property line or boundary of an adjoining property for all streets that provide access to an adjoining property.
- D. A building restriction line profile for a cul-de-sac shall be radial to the existing profile at the face of curb and proposed curb grade.

603.07 Street Centerline Profiles:

- A. A centerline profile shall be provided when a proposed street is an extension of an existing street. The profile shall be provided for a minimum distance of three hundred (300) feet to insure proper grade ties.
- B. A centerline profile shall be provided when a proposed street intersects with an existing street. The profile shall be provided for a minimum distance of three hundred fifty (350) feet in each direction to ensure an appropriate sight distance in accordance with Section 602.05 of this manual.
- C. A centerline profile shall be extended three hundred (300) feet beyond the property line or boundary of an adjoining property on all streets that provide access to an adjoining property.

603.08 Street Grade Lines and Cross Sections:

- A. Elevations shall be provided at the beginning and end of all vertical curves.
- B. Centerline elevations shall be computed and shown on the plans at fifty (50) foot intervals. Centerline elevations in vertical curves shall be computed and shown on the plans at twenty-five (25) foot intervals. Centerline elevations shall be shown on the plans for all street intersections, all street intersections with subdivision boundaries, and all curb returns.
- C. Points of finished grade shall be shown on a typical section (i.e., for the centerline, top of curb, drainage way, etc.).
- D. Superelevation rates and transition lengths shall be shown on the profiles in accordance with current VDOT standards.
- E. Sanitary sewer and storm sewer manholes that are in the paved area of the road shall be shown on the plans with finished elevations.
- F. Typical cross sections of all streets either standard or modified shall be shown on the plans. Categories and names of the streets shall be indicated on each typical cross section.
- G. All cross sections of streets including those designed with modifications such as, but not limited to, provisions of sidewalk on only one side of the street, superelevation, or any other modifications, shall be provided on the plans with appropriate station limits.

603.09 Street Cul-de-sacs:

- A. Grade profiles for cul-de-sacs with curb and gutter shall be indicated for the beginning of the curb return, following along the face of the curb around the cul-de-sac, and then to the end of the return, opposite the point of beginning.
- B. Grade ties of the street entering the cul-de-sac shall be shown on each end of the cul-de-sac grade profile to insure proper grade connection. Other approved methods may be used, subject to approval of the Director of Transportation and VDOT.
- C. If a cul-de-sac is proposed as a temporary turnaround at the end of a street, final grading of the proposed extension of the street shall be shown on the grading plans for a distance of three hundred (300) feet beyond the property line.

603.10 Street Pavement: A note shall be provided on the plans that subbase depth is based on CBR value of ten (10). CBR tests on subgrade material shall be performed for actual determination of required pavement thickness prior to the placement of subbase/base material. CBR tests are required for streets within single family detached, single family attached and condominium developments. CBR tests are not required for private streets within multi-family, commercial, office, industrial or institutional developments.

603.11 Street Curb and Gutter: If the proposed curb grades differ from one side of the street to the other, top of right curb elevation and top of left curb elevation shall be shown on the plans.

603.12 Street Landings: Standard street landings shall be shown on the plans with an indication of adequate sight distance.

603.13 Street Entrances:

A. Driveway entrances (including pipestem driveways) shall be shown on the plans, with the size, length, and type of entrance culvert, where required.

B. The distance of the entrance to the nearest intersection in both directions shall be shown on the plans.

C. The intersection sight distance shall be shown on the plans and verified through a profile. Sight distance easements shall be provided in accordance with sections 602.05 and 603.05 of this manual.

D. Adequate vehicular clearances and entrance radii shall be shown on the plans at all entrances to insure the safe movement of the projected traffic volumes and the types of vehicles using the site.

603.14 Street Ditches:

A. All roadside ditches shall be shown in plan view. Ditches shall also be shown in profile view where the depth of cut is not in conformance with typical sections.

B. The computations for determining the need for a paved ditch shall be shown on the plans.

C. Paved street ditches shall be shown on the plans. The limits of paved ditches shall be labeled on the plans and profiles. Easements for ditches shall be shown on the plans when required.

D. The plans shall provide the following note: "A joint inspection will be held with the developer and representatives of the County and VDOT to determine if and where paved ditches will be needed. The developer shall be responsible for providing paved ditches as determined by this joint inspection."

603.15 Guardrails:

A. Guardrails shall be shown on the plans when required in accordance with Section 602.12 of this manual. Their cost shall be included in the performance bond estimate.

B. The plans shall provide the following note: “A joint inspection will be held with the developer and representatives of the County and VDOT to determine if and where guardrails will be needed. The developer shall be responsible for providing guardrails as determined by this joint inspection. The guardrails shall be installed per VDOT standards prior to granting the first occupancy in each section, in which streets are constructed and the guardrails are determined necessary.”

603.16 Storm Sewer and Utility Lines in Relation to Streets: Proposed and existing storm sewer culverts, storm sewer crossings, sanitary sewer crossings, and utility crossings shall be shown on all street profiles at the proper location and grade.

A. In general, the allowable pipe types for storm sewer systems under or within the public street right-of-ways shall be concrete. However, other types such as high density polyethylene pipes (HDPE), corrugated steel, corrugated aluminum alloy or other similar types may be considered subject to compliance with the Virginia Department of Transportation (VDOT) current standards and specifications.

B. High density polyethylene (HDPE) corrugated culverts and storm drain pipes, where allowed and approved by VDOT, shall conform to specification requirements of the most current edition of the Road and Bridge Specifications Manual. They shall also conform to the requirements M252, M294 or MP6-95 of AASHTO and circular IIM-LD-121. Installation shall be in accordance with ASTM D2321. High density polyethylene (HDPE) pipes for storm drains and entrances shall conform to classification Type S. For all other applications, they shall be Type C.

C. High density polyethylene (HDPE) pipes and fittings shall be certified by the manufacturer before installation. The certification shall indicate that they have been tested and conform to the VDOT polyethylene-corrugated products quality assurance program. The certification shall be stamped on all shipping bill or invoice forms and be made available upon request of the County inspectors.

603.17 Stream Profiles in Relation to Streets:

A. Stream profiles of the top of a stream bank shall be provided when a street is proposed parallel to, or near an existing stream or drainageway. In addition, the plans shall provide the computed water elevations and invert (or flow line) of the stream or the open drainageway.

B. The stream profile shall show the relationship of the proposed street grade to the existing profile of the stream or open drainageway.

603.18 Street Slope Easements:

A. Slope and maintenance easements shall be shown on the plans where required.

B. The end of street construction shall indicate a three-to-one (3:1) maximum slope with the necessary easement shown on the plans.

603.19 Erosion Control for Streets: The erosion control measures at the end of curb and gutter construction shall be shown on the plans.

603.20 Street Lighting Plan:

A. A roadway lighting plat showing the proposed roadway luminaire easements shall be shown on utility plats, prepared and recorded by the servicing utility company.

B. A roadway luminaire symbol must appear on the final site plan at the required locations. The symbol must be coded as follows:

Street Classification	Standard Lumina Rating	Symbol
Residential Local and Minor Collector	8,000 lumens 100-watt HPSV or LED equivalent	SL-10
Major Collector	14,000 lumens 150-watt HPSV or LED equivalent	SL-15
Arterial Type 1, 2, and 3	23,000 lumens 250-watt HPSV or LED equivalent	SL-25

HPSV - High Pressure Sodium Vapor

C. The installation of turnpike, expressway, or interstate type roadway lighting fixtures are required for roadways with clear zone distances exceeding twenty (20) feet. The final site plan symbol must be coded as SL-40. This represents a 44,000 lumens 400-watt HPSV luminaire.

D. Lighting plan details or references shall be submitted to the Department of Transportation as part of site development plan review. All luminaires shall be designed to be full cut off styles with Type III light distribution in order to minimize glare and the impact to night skies.

E. The design of the lighting plan shall be coordinated with the existing and future locations of easements, utilities, sidewalks, driveway entrances, street signs, tree locations, traffic signal poles, and existing roadway luminaires.

F. Alternative roadway lighting fixtures and plans must be submitted to the Department of Transportation and VDOT for review and approval.

603.21 Street Barricades: Traffic barricades shall be shown on the plans, where required. This shall be provided in accordance with Detail 650.49 of this manual.

603.22 Street Names:

A. All new street names shall be reviewed and approved by the Department of Information Technology (DoIT) prior to approval of the preliminary site or subdivision plan.

B. Proposed street names shall be shown on all preliminary and final site development plans and plats. DoIT shall require a symbol on the plans that street signs shall be placed in locations that best identify named travelways and streets.

C. Subdivision plats shall not be signed and released for recordation, or building permits issued, until approved street names are shown thereon.

D. Street type designations which appear on the plans or plats, prior to assignment by DoIT may be voided and changed.

E. Names shown and approved on the preliminary plan or the final plan shall be reserved only for the period that the plan remains valid.

F. An applicant may submit street names to DoIT for conditional approval electronically, verbally or in writing prior to the submission of the plans. Reservation of street names for future use shall not mean that the name has been approved for use.

G. Approval of all street names shall be obtained from DoIT. New street names shall not duplicate or closely approximate (in spelling or sound) street names already assigned or reserved within the county, cities, or towns, which lie within the county boundary, regardless of jurisdiction. Confusing or unusual street name spellings shall not be permitted.

H. Street names shall not exceed seventeen (17) characters in length, including spaces between words and excluding the street type designation. Names containing hyphens, apostrophes, or other non-letter characters shall not be approved

I. Street names shall not contain more than three (3) words, with the exclusion of the street type.

J. Streets continuing through an intersection shall keep the same name. Exceptions to this requirement may be authorized by DoIT, in the event that a street crosses a major arterial road. Cul-de-sacs directly opposite each other, which intersect with a common street, shall have differing street names.

K. Commercial, multifamily, and single-family attached developments that have an entrance or access from a publicly maintained cul-de-sac, may be required to have a separate street name for the entrance or access street. This requirement shall apply if the entrance or access street serves, or is intended to serve, a structure(s) which requires assignment of more than three (3) address numbers.

L. Compass points, such as "north" and "south" shall not be used in street names.

603.23 Street Names in Relation to Street Type:

A. Once the street type is determined during the review of the site development plan (usually the last part of the street name) the street name shall be approved in accordance with the street classifications related to the following street type designation guide. These street type designators are the only designators which will be approved by the Department of Information Technology.

1. Principal Arterial - multilane highway normally four (4) lanes, controlled access, divided: Parkway, Boulevard, Pike, Expressway, Throughway.
2. Minor Arterial - multilane, controlled access, secondary traffic arteries carrying high volume traffic: Highway, Avenue, Road.
3. Collector Street - two (2) or four (4) lanes providing access: Avenue, Street, Road, Drive.
4. Local street providing access to individual lots within a subdivision or commercial area: Lane, Drive, Way, Trail, Loop, Circle.
5. Local street having one way in and out such as a cul-de-sac: Court, Place, Terrace, Turn.
6. Ingress/egress to shopping centers or malls: Square, Arcade, Center, Plaza.
7. Travelway usually behind housing and not used for normal through travel: Alley.
8. Pipestem driveways requiring names: Mews.

B. All permitted private streets and travelways shall be named in accordance with Section 603.22 of this manual.

C. Street names shall also be subject to the provisions of Chapter 24 of the County Code.

603.24 Street Addresses:

A. Street addresses shall be assigned by Department of Information Technology (DoIT) during the final site development plan review and/or site development plan permit application. The assigned addresses shall be returned to the engineer or developer in hard copy or electronic format.

B. Determination of the proper street address for corner lots shall be based upon the street from which the driveway is accessed. If a driveway accesses more than one street, the proper address shall be determined by DoIT.

C. Street addresses shall be subject to the provisions of Chapter 24 of the PWC County Code. Full (street number, street name, street type) or partial addresses shall be conditionally required by DoIT to be posted in multiple locations.

D. Addresses shall be drafted onto the original final recorded plat and site plan, and resubmitted to the County for review. Plats and/or plans will not be approved without street addresses.

E. A sign showing the range of addresses for each lot served by a pipestem driveway shall be provided at the entrance of a pipestem driveway. DoIT shall conditionally require additional address range signs. The sign shall meet all applicable provisions of Detail 650.60 of this manual. A note or symbol referenced to a note shall be placed on the site development plan at the proposed location of the address range sign. The note shall include the proper numbers for each address as assigned by DoIT.

F. Multifamily apartment or condominium developments, including conversions, shall have apartment or unit numbers assigned by DoIT with the street numbers.

G. The entrance to each commercial or residential building and to units within a building must be clearly identified on the final plans. Floor plans detailing the configuration of the building, separate levels, location of sprinkler rooms, fire alarm control panel rooms, electric rooms and common entrances, as well as individual unit entrances, shall be submitted to DoIT.

H. Plans for variable office, warehouse, and retail space shall specify the maximum number of units possible within the overall structure. The number shall be broken down by level for multistory structures.

I. Addresses will be assigned only after receipt of the information required to properly assign addresses.

603.25 Plats:

A. Privately maintained streets and travelways shall be platted such that all lot owners are assured perpetual right of access to a state maintained road.

B. The final recorded plat shall note ownership and maintenance responsibility of private streets, travelways, pipestem driveways, and common driveways.

C. The plat recorded for residential development served by private roads shall contain the following statement highlighted in a box: "The road serving this development is private and is not eligible for acceptance into the State street system. Maintenance of the road, including snow removal, is not a public responsibility."

D. The final plat shall also note the following: "An adequate easement for ingress, egress, construction, maintenance of utilities for County and other emergency vehicles shall be provided where a common access easement is used." This shall also apply to travelways that provide access to multi-structure commercial, industrial, and residential development. The final plat shall note that the easement is privately owned and maintained by the owners or association.

E. Lots served by pipestem driveways shall be noted on the plat as follows: "Owners of lots that access through common driveways assume an obligation for maintenance of the common driveway, which obligation is a condition of their ownership of the property and which runs with the land. Parking shall not be permitted within the minimum ingress/egress easement section required by the Design and Construction Standards Manual."

F. For lots located on a temporary turnaround easement, minimum front setback requirements shall be maintained from the easement line instead of the lot line.

604.00 TRANSPORTATION SYSTEMS - CONSTRUCTION STANDARDS

604.01 Street Construction:

A. The methods and materials used in the construction of all streets shall be in conformance with requirements of the current VDOT road and bridge specifications, Virginia Erosion and Sediment Control Handbook, and this manual.

B. All street construction, including sidewalks, shall be within the dedicated street right-of-way or the required easements. Grading may be done in adjoining easements.

C. Street construction shall be for the full frontage of all lots.

D. The required thickness of subbase, base course, and top or surface course shall be as shown in Detail 650.01 of this manual. Subbase and/or base thickness is based on subgrade CBR value of ten (10). The final pavement design shall be determined after CBR tests are performed at the developer's cost in accordance with sections 602.10 and 602.11 of this manual. CBR test results for ultimate pavement design shall be submitted in a form approved by the Director of Transportation.

E. For streets under construction, which are not yet accepted into the State system, the developer shall be responsible for providing traffic controls in accordance with VDOT specifications.

F. No occupancy permit will be issued to any structure(s) unless the frontage improvements and all roadways within the specific phase including the main entrance are paved. Full pavement depth, with the exception of the final top coat, is acceptable provided it is agreed to by Transportation.

G. At the conclusion of street construction, all equipment, forms, barriers, excess material and related items shall be removed from the site. Final approval of the construction shall include proper clean up of the site.

H. All construction sites shall be provided with temporary signs acceptable to Transportation referencing the requirements of Section 14-4(c) of the Prince William County's Noise Ordinance. The signs shall be conspicuously posted in all construction sites and fully visible to all construction personnel. The signs should be bi-lingual (written in English and in Spanish). Adherence to this requirement shall be the responsibility of the developer(s) and/or contractor(s) and shall be monitored by the Department of Transportation. Violation of this sign posting requirement is a class II misdemeanor.

The temporary warning signs (one in English and one in Spanish), smaller than two square feet, shall be installed by the developer and/or contractor at each construction entrance of a project prior to the commencement of land disturbing activities. The signs shall read:

WARNING

PRINCE WILLIAM COUNTY CODE PROHIBITS CONSTRUCTION WORK
MONDAY – FRIDAY: BEFORE 6:00 A.M. & AFTER 10:00 P.M.
WEEKENDS AND HOLIDAYS: BEFORE 9:00 A.M. & AFTER 10:00 P.M

AVISO

LA LEY DEL CONDADO DE PRINCE WILLIAM PROHIBE EL TRABAJO DE
CONSTRUCCION LUNES A VIERNES: ANTES DE LAS 6:00 A.M. Y DESPUES DE
LAS 10:00 P.M. SABADOS Y DOMINGOS Y DIAS FERIADOS : ANTES DE LAS
9:00 A.M. Y DESPUES DE LAS 10:00 P.M.

The developer must maintain these signs in good condition during the active life of a project. These signs shall be removed at the recommendation of the Department of Transportation prior to final site acceptance and bond release inspection.

These signs shall be exempt from zoning approval or permit requirements.

604.02 Street Curb and Gutter/Sidewalks:

- A. The curb and gutter shall have uniform sections, approximately ten (10) feet in length, and no section shall be less than six (6) feet in length.
- B. The aggregate material shall extend under the curb and gutter a minimum distance of six (6) inches beyond the back of the curb.
- C. The aggregate thickness under the curb and gutter or curb shall be a minimum of four (4) inches.
- D. The base and subbase material and subgrade for sidewalks and curb and gutter shall be compacted as per current VDOT road and bridge specifications.

604.03 Paved Ditches, Guardrails, and Retaining Walls and Noise Abatement Facilities:

- A. A joint inspection shall be held with the developer, representatives of the County, and VDOT to determine if and where paved ditches and/or guardrails shall be needed. The developer shall be responsible for providing paved ditches and guardrails as determined by the joint inspection. The guardrails shall be installed per VDOT standards prior to granting the first occupancy in each section, in which streets are constructed and the guardrails are determined necessary.

B. All retaining walls shall be required to comply with Section 710.06 of this manual, the VUSBC and the VDOT road and bridge specifications. A single retaining wall or a tiered retaining wall system that retains a total elevation difference greater than forty-eight (48) inches needs a vehicular barrier treatment when travelways or parking spaces are located within 10 feet of the face of wall. This barrier treatment is in addition to pedestrian fall protection devices such as railings or fences. Barrier treatment may include guardrail (strong post system), concrete traffic barriers, raising the height of the retaining wall a minimum of twenty-seven (27) inches (height of standard guardrail) or other means as approved by the Director of Transportation. If guardrail is used, there must be a minimum of three (3) feet between the face of wall and the guardrail post. Retaining walls shall be shown in plan and cross section view showing the retaining wall, barrier device, and appropriate dimensions.

C. When a residential development is proposed adjacent to an existing interstate roadway a noise impact assessment study is required. If it is determined that the traffic noise levels (based on ultimate roadway improvements) exceed VDOT's minimum standards, noise abatement facilities acceptable to VDOT and the County shall be provided.

D. When a residential development is proposed adjacent to a planned or existing principal arterial roadway a noise impact assessment study is required.

E. Site plans addressing noise abatement facilities must be designed separately and shall be submitted to the Department of Transportation and VDOT for approval, prior to their incorporation in the final development plans. The facilities shall be designed to reduce traffic noise levels using acceptable engineering criteria and methods such as the use of berms, wide buffers, masonry or sound walls, and/or grading.

F. Noise abatement facilities associated with residential developments shall be provided outside the right-of-way and contained in an easement. Maintenance, including removal of graffiti, shall be the responsibility of the homeowners association (HOA).

G. In lieu of noise abatement facilities, the developer may provide a five hundred foot (500') undisturbed buffer measured from the right-of-way line to the residential lot property line. This buffer shall be shown on the subdivision plat.

604.04 Street Signs:

A. Streets that end in a temporary cul-de-sac, but are to be ultimately extended to provide access to adjacent development, shall be posted with signs indicating possible extension of the street. The sign shall read: "THIS STREET MAY BE EXTENDED IN THE FUTURE. FOR INFO, CALL Prince William County Department of Transportation at 703-792-6825". At least two signs shall be provided, one at the temporary cul-de-sac and another at the entrance to the street to be extended. These signs shall be installed prior to placement of the base asphalt.

B. Dead end streets with cul-de-sac lengths exceeding two hundred fifty (250) feet and streets on which cul-de-sacs are not visible from the intersecting streets shall be posted with warning signs stating the following: "NO OUTLET" or "DEAD END." The design and construction of these warning signs shall conform to Detail 650.55 of this manual.

- C. Street name signs shall not be installed until the street name is approved by DoIT.
- D. Street name and other signs may be purchased through the Prince William County sign shop and paid for by the developer.
- E. Street name signs and stop signs shall be posted at all street intersections, and at all entrances to parking bays for residential development. Temporary street signs must be posted before the use of vehicular traffic, inclusive of construction vehicles. Permanent street signs and stop signs must be posted prior to the occupancy of any house or unit being served by the street.

604.05 Street Traffic Control Signs:

- A. Prior to acceptance of a street in the state secondary system, the developer shall be required to post the necessary traffic control signs, inclusive of pavement markings.
- B. Prior to school opening, all necessary pavement markings, traffic control signs, traffic safety devices and/or equipment required by VDOT and the County shall be provided or installed on roadway(s) adjacent to and within the school site.
- C. Traffic control signs shall conform to VDOT standards and the current edition of the Manual on Uniform Traffic Control Devices (MUTCD).
- D. Stop signs and other traffic control signs shall be posted at all intersections of streets or travelways that each carry greater than five hundred (500) vehicles per day (vpd), including those intersections with state maintained streets and, if warranted, using the latest requirements in MUTCD and VA Supplement to MUTCD for Streets and Highways.
- E. Prior to the release of the performance bond, county inspectors may require safety features such as no parking regulation signs, speed limit signs, stop signs, pavement markings, and traffic barricades. These items shall be installed at the developer's expense.

604.06 Street Name Signs:

- A. Street name signs shall be installed at all street intersections in accordance with Details 650.52 and 650.53 of this manual.
- B. Street name signs shall have a minimum height of nine (9) inches a minimum width of twenty-four (24) inches and a maximum width of forty-two (42) inches. Widths greater than forty-two (42) inches may be allowed in special cases upon approval of the Director of Transportation.
- C. Spacing between letters within a street name should conform to the spacing dimension shown in the Virginia Supplement to the Manual on Uniform Traffic Control Devices for Streets and Highways unless this will result in a sign width greater than specified in Section 604.06B. In such cases, the space between letters may be reduced proportionately to a minimum of one-half (0.5) inch at the closest point between two adjoining letters. If further reduction is required, series B letters may be used.

D. The normal spacing between words shall be the width of the letter "H" in the same series and height used in the words. If block names are used, they shall be the same letter series and height as the suffix and shall be placed directly above the suffix.

E. As a minimum, all street name signs shall be fabricated with high intensity reflectorized sign sheeting. Sign text and numerals shall be white and the background shall be green.

F. For streets constructed in accordance with Details 650.02 thru 650.05, 650.07 and 650.08, at least one street name sign assembly should be mounted at each intersection. Signs naming both streets should be erected at each location with their faces mounted parallel to the streets they name.

For streets constructed in accordance with Details 650.09 thru 650.13, street name sign assemblies should be placed at least on diagonally opposite corners. Signs naming both streets should be erected at each location with their faces mounted parallel to the streets they name. Street name signs shall be placed in a manner that will allow them to be plainly seen by approaching motorists and not interfere with or block the motorists' view of other signs.

G. All street name signs shall have a blank space at least two and one half (2.5) inches high and nine (9) inches wide provided in the lower right-hand corner of the sign to accommodate a decal, provided and installed by the developer once VDOT assigns the appropriate route number preceded by the letter "SR". Decals may be purchased from the Prince William County sign shop.

H. The shorter nameplate shall be mounted over the longer nameplate in assembly.

I. For ditch section streets, the street name sign shall be installed so that the longest nameplate is a minimum of two (2) feet behind the ditch line.

J. For curb and gutter streets, the street name sign shall be installed in the grass utility strip near its terminus at an intersection.

K. Street name signs that are to be installed on galvanized poles shall be provided in accordance with Detail 650.52 (SNS-1) of this manual.

L. Street name signs (SNS-2) (Detail 650.53) shall be installed on traffic signal poles of major intersections of streets designated to carry traffic volume exceeding seven thousand (7,000) vehicles per day (vpd).

M. For privately maintained streets and travelways constructed in accordance with Detail 650.06, the street name shall be installed in accordance with Detail 650.52 of this manual.

604.07 Privately Maintained Travelways and Streets: The design specifications methods and materials used in the construction of all private streets and travelways not maintained by VDOT shall conform to the current VDOT road and bridge specifications, Virginia Erosion and Sediment Control Handbook, and this manual.

604.08 Privately Maintained Travelway Signs:

A. Any street or travelway within a development which is not incorporated into the state secondary system shall be identified with a sign attached to the street sign or address sign (for pipestem driveways), and shall state the following: "Private Street, Not Public Maintained." The sign shall be twelve (12) inches by eighteen (18) inches, and shall conform with Detail 650.56 of this manual.

B. Private maintenance designation signs and address range signs may be purchased by the developer through the Prince William County sign shop and installed in conformance with Details 650.56 and 650.60 of this manual.

C. On privately maintained streets and travelways, stop signs shall be provided and posted at all intersections of roads or travelways that each carry greater than five hundred (500) vehicles per day (vpd), including those with state maintained streets and, if warranted, using the latest requirements in MUTCD and VA Supplement to MUTCD for Streets and Highways.

604.09 Traffic Signal – VDOT and PWC Pre-Emption Systems: New traffic signals shall include pre-emption systems that are approved by both VDOT and PWC. Signal modifications shall also include VDOT and PWC approved traffic signal pre-emption equipment to be incorporated into existing traffic signals. This is to be coordinated with the Department of Fire and Rescue who will determine which approaches should have the equipment and will be a requirement for traffic signal plan approval.

610.00 TRANSPORTATION SYSTEMS - OFF-STREET PARKING

610.01 General Requirements for Off-Street Parking:

A. The off-street parking and loading spaces required by the schedule in Section 610.02 below are minimum standards. Additional parking and loading spaces may be required as part of the site plan review, special use permit and zoning map amendment processes. All uses shall provide off-street parking and loading spaces in a number sufficient to handle the normal demand of employees, customers, and deliveries. When separate parking tabulations are required for components of a use, the square footage used for a component use shall be deducted from the square footage of the total use for general parking tabulation requirements. For uses not specifically listed in Section 610.02, Table 6-8, the Director of Transportation, with the concurrence of the zoning administrator, shall require a minimum number of parking and loading spaces, based on the most similar use that is listed. For any individual use, the Director of Transportation may require additional off-street parking and loading spaces when the operation of that use shows a repeated need for more spaces, based upon the intensity of a particular use proposed, by reference to the general standards provided in these sections.

B. The off-street parking and loading spaces required by Section 610.02 shall be reserved for, and located upon the same property, as the use for which they are required, except as provided in sections 610.03 and 610.04 of this manual. No off-street parking shall extend into any public right-of-way or required buffer area. Parking and loading spaces required for all uses, except one-family and two-family residential uses, shall have direct access from an interior driveway, and shall not necessitate backing from the space into any public street.

C. Parking and loading spaces (based on the square footage of a building) shall be calculated on the net floor area. Spaces based on the number of employees shall be calculated on the maximum number of employees normally present at any one time. Spaces based on the capacity of a building shall be calculated on the occupancy load allowed by the VUSBC. Spaces based on the number of seats, when benches are used, shall be calculated on every eighteen (18) inches of bench space counting as one seat.

When the calculations of parking and loading spaces result in a fraction of five-tenths (0.5) or greater, the next greatest whole number shall be used. Parking and loading spaces required for two (2) or more uses on the same property shall be the sum of each use, except when a parking credit allowance is approved, as set forth in Section 610.03 of this manual.

D. Up to fifty percent (50%) of the required off-street parking may be located on an adjacent or abutting property if allowed by the Zoning Ordinance. In addition, where pedestrian access in the off-street parking requires traversing a public or private street designated or presently carrying traffic volumes equal or greater than major collector or arterial roadways, a pedestrian underpass, overpass, or traffic signal shall be required. Wherever parking is permitted pursuant to this section, appropriate instruments noting the restricted use of the adjacent property for parking purposes shall be recorded among the land records.

E. For churches or places of religious worship or assembly or religious institutions with related facilities in the agricultural and residential zoning district, up to fifty percent (50%) of the required off-street parking may be located on one (1) adjacent lot per Section 610.01D of this manual, or on one (1) satellite parking lot with special use permit (in accordance with sections 32-300.07 of the Zoning Ordinance, provided appropriate instruments noting the restricted use of the adjacent or satellite property for church, religious institution, or public use (such as a commuter lot) parking purposes shall be recorded among the land records, and provided the satellite parking lot is zoned agricultural or residential.

F. In circumstances when no customer or public entrance or access is located at the rear, no more than five percent (5%) of the required spaces shall be located in the rear of buildings or retail uses.

G. In the event a question shall arise regarding the classification of a use for application of these standards, the Director of Transportation shall determine the classification after consultation with the zoning administrator.

H. All required access streets, aisles, travelways, and parking lots, except those used for single-family detached lots or areas used for vehicle storage in the M-1 and M-2 zones, shall be constructed and maintained with a paved surface. In commercial developments, paved parking areas shall be required or demonstrated to be available for each tenant requesting an occupancy permit. Paved parking areas and structures shall be designed in accordance with this section and Detail 650.06 of this manual. The Director of Transportation may allow a waiver for the use of alternate surfaces such as dustless surface, GEO GRID or grass reinforcing for aisles, travelways, off-street parking in commercial developments or developments maintained by the property owner. It will be based upon determination that such alternative of modifications will not have an adverse impact on the surrounding area and on the site. The adverse impact may include but not be limited to, circulation, public safety, storm drainage and/or storm water management, water quality and erosion and sediment controls.

I. Visitor parking spaces should be dispersed evenly throughout the development in close proximity to the units they serve.

610.02 Parking and Loading Spaces Required:

A. Off-street parking and loading spaces shall be provided for every use allowed by the Zoning Ordinance in accordance with the provisions of Table 6-8.

B. When ancillary uses are itemized in conjunction with a calculation for nonresidential uses, the square footage calculated for the ancillary use shall be deducted from the square footage of the overall use.

C. Bicycle racks, lockers, or docking stations for bike sharing programs shall be considered in the vicinity of all existing and proposed transit stops along arterial and collector corridors within the County by a designated public transit agency operating within the County or by private development with proffered or conditioned commitments to provide a transit stop in conjunction with development approval.

The following factors will be considered by the County for a determination:

- Whether existing bicycle racks and /or bicycle locker facilities and docking stations are already in place at or within ¼ mile;
- Where there is substantial proximate residential, commercial and office development in the vicinity;
- Whether the transit stop is located on an arterial or collector road facility;
- Anticipated demand for bicycling in the area;
- Safety considerations;
- Ability to accommodate bicycle parking facilities within the transit stop footprint;

If determined to be appropriate by the County, a minimum of 5 bicycle spaces will be provided at each designated transit stop.

610.03 Parking Credit Allowance: The Director of Transportation, with concurrence of the zoning administrator, may authorize, upon request of a property owner, a parking credit allowance. Such requests shall be in writing, shall state the reasons for the request, and shall include studies, surveys, reports or other evidence to support the request. A parking credit allowance may be authorized as follows:

A. Up to thirty percent (30%) of the required parking spaces may be waived when the use is located in an area of development that is so intense that normal individual demand will not be generated. In considering this waiver request, weight shall be given to the availability of public transportation, the proximity of commercial parking garages or lots, and the expected overlap of commercial and employment activities in the area.

B. Credit may be given for parking spaces required for one use when parking spaces required for another use on the same lot, or on an adjacent lot, approved under Section 610.01D of this manual, can be used because of a difference in normal operating hours. This credit may be given for up to seventy-five percent (75%) of the required spaces when no overlap in normal operating hours occurs, and up to twenty-five percent (25%) of the required spaces when an overlap of less than four (4) hours per day occurs, provided a legally sufficient agreement is executed when different property owners are involved.

C. All parking credit allowances shall be subject to the authority of the zoning administrator to increase spaces under the provisions of Section 610.01A of this manual

610.04 Parking Deferrals: Up to fifty percent (50%) of the required spaces may be deferred provided there is sufficient area, as shown on the site plan, to construct the deferred spaces, and provided a written agreement, binding on all present and future property owners, is submitted stating that the deferred spaces shall be constructed when, in the opinion of the Director of Transportation and the zoning administrator, such construction becomes necessary.

610.05 Setbacks: Parking and loading spaces, and travelways, except for one-family and two-family residential use, shall be set back as follows:

A. At least ten (10) feet from any street right-of-way.

B. At least ten (10) feet from all other property lines, except at least fifteen (15) feet from property lines where a nonresidential use abuts a residential district.

C. Interior driveways or travelways shall be subject to the setbacks in paragraphs A and B of this section, except where joint driveways or travelways are authorized by the Director of Transportation. Entrances and exits off a public street shall be subject to the setbacks in Minimum Standards of Entrances to State Highways Manual of VDOT, except where joint entrances and exits are authorized by the Director of Transportation.

D. Motor vehicle service fuel sales facilities shall have a minimum setback distance from the pump islands to the ultimate right-of-way line in accordance with Table 6-9.

E. All setback areas required under this section shall be landscaped and/or screened in accordance with Section 800.00 of this manual.

F. Self-service gas stations shall be approved by the Fire Marshal's Office and installed in accordance with their specifications, and the requirements of VUSBC.

610.06 Layout and Design:

A. All parking and loading spaces (including required accessible parking), driveways, entrances and exits shall be designed and surfaced in accordance with Detail 650.00 of this manual.

B. For single-family attached/fee simple and condominium development except on medium to high rise (3 story and above) development with private driveways and parking areas owned by a homeowners association, required off-street parking, except parking required for boats, trailers, and similar vehicles, shall be provided on each lot or within one hundred fifty (150) feet of each dwelling unit measured over sidewalks or other paved surfaces. Parking spaces must be labeled (e.g., street address, lot number, etc.), either to designate the single-family attached dwelling unit they serve or to indicate that they are reserved for visitors.

C. For single-family attached and multifamily developments, required off-street parking spaces shall be demarcated by four (4) inch white lines painted on the pavement or the curb. Any other proposed color and size will require prior approval of the Director of Transportation. Full delineation by 4" wide lines painted on the pavement showing the full width or length of the parking stall or parking spaces shall be required on commercial, office and industrial developments. Where paved parking areas are not required, delineation of parking spaces shall be by the use of individual wheel stops or other acceptable means for each unpaved parking space.

D. Before occupancy of any single-family attached unit, the parking spaces assigned to the particular unit should be demarcated or marked (labeled) on the curb.

E. In general, private travelways and parking areas owned by the homeowners association (HOA) which are not illuminated by the required street entrance lights shall be illuminated. The average illumination level required shall be 0.2 to 0.5 foot-candles (2.20 to 5.50 lux). High pressure sodium (HPS) luminaires with 3,800 initial lumens on mounting height not to exceed eighteen (18) feet are desirable. At a minimum, four (4) luminaires (two on each side) spaced at one hundred (100) feet maximum within the parking bays and/or travelways shall be provided. However, at the discretion of the engineer and the utility company, an equivalent type of fixture will be allowed with the approval of the Director of Transportation. The luminaires shall be directed downward. Areas opposite the single-family attached units or main entrances of multifamily buildings will require illumination on one (opposite of building or row of units) side only.

F. Outdoor lighting shall be provided in accordance with section 250.200 of the Zoning Ordinance. All outdoor lighting fixtures shall be designed, shielded, aimed, located and maintained to shield adjacent properties and to prevent glare onto adjacent properties or roadways. Parking lot light fixtures and light fixtures on buildings shall be full cut-off fixtures.

G. The engineer or developer can provide different design, arrangement and/or types of luminaires if approved by the utility company. Such design will require the approval of the Director of Transportation prior to installation.

H. The cost of luminaires shall be bonded with the County during the site plan approval. The luminaires shall be installed prior to occupancy of any unit in which the luminaires service. Deviation from this requirement, due to utility company policies, will be reviewed and approved on a case-by-case basis by the Director of Transportation.

I. For commercial and office developments, required off-street parking spaces shall be demarcated by four (4) inch white lines painted on the pavement. Any other proposed color and size will require prior approval of the Director of Transportation.

J. Off-street parking areas shall have appropriate bumper guards where needed, as determined by the Director of Transportation. Header curb may be substituted for bumper guards, provided it is located at least ten (10) feet from any property line. This will avoid vehicle overhang into adjacent properties.

K. When a nonresidential use abuts a residential use, the parking and loading spaces in the nonresidential use shall be set back fifteen (15) feet from the property line and the screening requirements shall be met.

L. Off-street parking is to be provided with safe and convenient access to a street. Where spaces and travelways are located contiguous to a street, they shall be set back at least ten (10) feet from the right-of-way. The side of the parking area and travelways adjacent to the street shall be curbed, allowing for ingress and egress through approved driveway locations. Design necessitating backing from a space into a street or entrance shall not be permitted.

M. Generally, parking areas shall be graded at a slope not to exceed five percent (5%); maximum slope shall not exceed ten percent (10%) with the exception of accessible spaces. However, design should take into consideration accessibility requirements.

N. Travelways shall be a minimum width of twenty-two (22) feet. One-way travelways may be permitted by the Director of Transportation, due to site limitations. A one-way travelway may be a minimum of twelve (12) feet in width, provided there is no perpendicular parking along its length, it is clearly marked with signs and pavement markings and provided is not labeled as a fire lane. Angled parking may be provided in accordance with Table 6-10 of this manual.

O. The minimum dimensions of an off-street standard parking space should be in accordance with Tables 6-10 and 6-11 of this manual. When the angle of parking is ninety (90) degrees to the aisle and wheel stops are provided, a two (2) foot overhang measured from the face of the wheel stop contacted by vehicle tires shall be allowed, provided it does not overlap with the required area of surrounding spaces, encroach on the required landscape setback, or restrict pedestrian access. For angle parking other than ninety (90) degrees, the minimum dimensions required shall be in accordance with Table 6-10.

P. The minimum dimension of a standard loading space shall be at least twelve (12) feet by forty-five (45) feet and shall have a minimum vertical clearance of at least fourteen (14) feet. However, in a commercial, industrial project of more than one building, some of the required loading spaces could be reduced in length to thirty-five (35) feet as long as one standard loading space of twelve by forty-five (12 x 45) feet provided for each building.

Q. Parking spaces designated for compact cars may be provided. Each space shall be clearly marked. Such spaces shall not constitute more than twenty percent (20%) of the entire parking space requirement and meet the minimum dimensions outlined in Table 6-10.

R. Parallel parking spaces shall have a minimum length of twenty-two (22) feet and a minimum width of nine (9) feet.

S. All structured parking not below ground level shall meet the definition of "parking deck or garage" as defined by the Zoning Ordinance. Parking decks or garages are subject to the building setbacks for the zoning district in which they are located.

610.07 Off-Street Stacking Spaces:

A. For all uses with a drive-up window (banks, kiosks, etc., except restaurants) and for all uses involving customers waiting in line while in their vehicles (car washes, drive-in theaters, etc.), in addition to the parking space requirements of this section, off-street stacking spaces for at least six (6) motor vehicles shall be provided for the first window or unit, and thereafter five (5) off-street stacking spaces shall be provided for each additional window or unit. Where development uses require fewer than the required stacking spaces by a justifiable study, a waiver request may be considered on a case-by-case basis by the Director of Transportation.

B. For restaurants with drive-in, drive-up, or drive-through units or windows, eleven (11) on-site stacking spaces with at least six (6) queuing spaces from each order board shall be required. Five (5) stacking spaces shall be required between the order board and pick-up window.

C. For pharmacies with drive-up, or drive-through units or windows, four (4) stacking spaces shall be required for each window.

D. The minimum dimension for a stacking space shall be eighteen (18) feet by eleven (11) feet in its entirety. The stacking spaces shall not interfere with the travelways, parking, loading spaces, or island curbs.

E. The design of drive-through lanes for businesses that provide no more than one drive-through lane shall include provisions for an unencumbered lane that allows customers to by-pass stacked vehicles.

610.08 Accessible Parking:

A. Accessible parking and building or sidewalk accessibility shall be provided in accordance with the current edition of the Virginia Uniform Statewide Building Code (VUSBC).

B. Accessible parking spaces shall be identified by above grade signs and demarcated in accordance with Details 650.57 and 650.58 of this manual and ADAAG (Americans with Disabilities Act Accessibility Guidelines) standards.

C. Accessible parking spaces shall be located as close as possible to a main building entrance ramp or walkway. However, the Director of Transportation may require some spaces at alternate locations to provide greater accessibility for the entire development. A combination of ramps, walkways, crosswalks or curb ramps shall be required in conjunction with those spaces.

D. Where curb exists between the parking lot and sidewalk, an inclined approach shall be provided to allow convenient access for wheelchairs. Built-up curb ramps shall be located so that they do not project into vehicular traffic lanes. This approach shall have a slope of not more than one (1) foot in twelve (12) feet and be three (3) feet wide, exclusive of flare sides. Inclined approaches shall be provided and arranged to allow convenient access to a building entrance and from one (1) curb area to another. Such approaches shall be provided at intervals not exceeding one hundred (100) feet.

E. A request for modification of any of the requirements of this section must be submitted in writing to the Director of Transportation.

610.09 Layout and Design for Motor Vehicle Fuel Sales and Convenience Food Stores:

A. Off-street parking spaces shall be demarcated with paint and equipped with wheel stops where deemed necessary by the Director of Transportation.

B. Stacking spaces shall not interfere with the travelway traffic or the designated parking spaces. The width of a drive-through travel lane shall not be less than eleven (11) feet. A stacking space shall have a minimum length of eighteen (18) feet.

C. Each gasoline pump island shall be located so that there is a refueling area of at least ten (10) feet in width on both sides of the pump island. A minimum of twenty (20) feet is required between pump islands. Gasoline pump islands shall be protected at each corner by a vertically imbedded metal post filled with concrete at least thirty (30) inches in height above the ground and three (3) inches in diameter.

D. Travel lanes shall be a minimum of twenty-two (22) feet in width between any refueling area at the pumps and any parking spaces provided on-site.

610.10 Parking Lot Landscaping: Parking lots shall be landscaped in accordance with Section 800.00 of this manual.

610.11 Outdoor/Roadway Lighting: Where required by the Zoning Ordinance site plans submitted to the County shall include illumination plans conforming to the policy, details, illumination level standards and requirements of Sections 32-250.200 of the Zoning Ordinance, VDOT/AASHTO Roadway Lighting Standards and street lighting standards of this manual. Photometric plans, illumination plans and details prepared by an illumination engineer shall be provided for review and approval.

620.00 TRANSPORTATION SYSTEMS - TRAFFIC IMPACT ANALYSIS

620.01 Title and Purpose:

- A. A traffic impact analysis (TIA) is a study which provides information on the impacts of vehicle trips generated from the proposed land uses on traffic safety and operation within a designated area and provides recommended solutions to mitigate the impacts.
- B. The purpose of these requirements is to provide a clear, concise set of guidelines for the designation of the area to be studied, the analysis and methodology, and the recommendations to assess the traffic impacts of development proposals on the existing and future transportation network. In addition, they are designed to advise applicants what constitutes a comprehensive acceptable traffic impact analysis for development proposals in Prince William County.
- C. Any TIA not meeting the requirements of this section shall be considered incomplete and unacceptable.
- D. The requirement of TIAs for rezoning and site plan submission may differ. The primary focus of a site plan shall be on site access, circulation and internal roads. The rezoning study will focus on site access, internal roads and off-site assessments.

620.02 Administration:

- A. A TIA shall conform to all of the provisions of this section unless the requirements of specific subsections are modified or deemed not necessary by the Director of Transportation as a result of the pre-submission meeting. The applicant shall meet with the Director of Transportation or designee prior to preparation of any TIA to determine the scope of the TIA, which shall include the following:
1. The study area.
 2. Size and phasing of the proposed development.
 3. Clarification, justification, and agreement for all assumptions and methodologies to be used in the analysis.
 4. Submitted or approved plans, within the study area for estimation of background traffic.
 5. The future street construction/improvements in the study area which may impact the subject site.
 6. The applicant shall provide a written summary of the pre-submission agreements of the proposed analysis before proceeding.
- B. The applicant shall provide three (3) copies of the TIA at the time of submission of the site development plan application. Two (2) copies of the TIA shall contain computer disk(s) (CDs) containing computer files used in the analysis.

C. If the applicant fails to comply with the technical requirements and the scope of study outlined in the pre-submission meeting, the applicant shall be advised that the TIA must be revised.

D. Each TIA shall contain a signed and sealed Certification of Statement of the responsible person for the contents of the documents. The responsible person shall be certified or licensed to do traffic engineering or planning (PE, PTOE, AICP) professional work in the Commonwealth of Virginia.

620.03 Study Area:

A. The study area shall be determined with staff during the scoping meeting. However, generally, the study area shall consist of the area containing and/or surrounding the proposed development within which the transportation network is impacted in one of the following ways:

1. At a minimum, the study area shall include all site access driveways and intersections on adjacent roadways and all major internal intersections.
2. At least five percent (5%) of the average daily traffic (ADT) or peak hour(s) traffic of the roadways and/or intersections within the study area is composed of the development's new trips.
3. The generated trips from the proposed development changes the level of service of a roadway or intersection.
4. An identified dangerous roadway or intersection within the area identified above.

B. The study area shall also include any additional area deemed appropriate based on acceptable transportation engineering criteria.

620.04 Design Year: The design year shall be in accordance with the Table 6-12.

620.05 Traffic Data Requirements and Existing Conditions:

A. All existing traffic counts used shall have been conducted within the prior twelve (12) month period. The Director of Transportation shall determine if and what growth rate factor shall be used to update the counts (i.e., utilizing historical traffic counts or available data from a transportation model).

B. The peak hour(s) shall be determined using a minimum three (3) hour counting period on an average weekday (Tuesday - Thursday) not on a holiday, and conducted in favorable weather conditions or other period as deemed necessary. All count data, including daily traffic volumes, shall be presented in the study.

C. Existing conditions of the study area shall be documented including some or all of the following:

1. Roadway configurations (number and length of lanes and lane usage).
2. On-street parking availability and regulations.
3. Driveways serving developments on roadways adjacent to subject site.
4. Transit stops.
5. Posted speeds and current traffic count data.
6. Substandard roadway design features.
7. Adjacent land use.
8. Roadway geometrics and traffic controls such as traffic signals and stop and yield signs.

620.06 Trip Generation:

A. The estimated trip generation for each land use shall be obtained by utilizing the current edition of the Institute of Transportation Engineers (ITE) Trip Generation Manual. The appropriate land use code and independent variable units from the manual shall be indicated for each category.

B. The fitted curve equation shall be used for all trip generation estimates. For those land uses for which the equation is not available, average trip rates shall be used.

C. In addition to peak hour trip generation, the daily trip generation for all uses shall also be included in the report.

D. For commercial development (e.g., shopping centers), calculations for weekend trip generation, and capacity analysis shall be included in the report.

E. The peak hour trip generation for single-family attached dwelling shall be calculated by using the single-family detached housing category (land use category #210, ITE Trip Generation Manual, current edition). If an adopted local trip generation rate exists for a specific category, it shall be utilized.

F. A pass-by trip reduction factor up to fifteen percent (15%) may be considered for commercial development, upon concurrence of the Director of Transportation prior to preparation of the report. A pass-by trip reduction factor up to 49% AM/50% PM/50% Saturday for gas stations, convenience stores and fast food restaurants that front on a minor or primary arterial street will be considered by the Director of Transportation prior to the preparation of the TIA. Each case shall be considered individually. An internal capture rate reduction up to fifteen (15) percent may be considered on mixed use development.

G. Any trip reduction based on a mixed-use concept, pass-by trips, or transportation demand management (TDM) program, etc., shall be considered during the pre-submission meeting of the TIA. Only the following justifications shall be considered by staff for the purpose of defining a trip reduction rate:

1. Transit service (i.e., bus or rail service).
2. Developments which provide for less than two thousand (2,000) feet of uninterrupted walking or biking distance or uninterrupted pedestrian movement facilities (such as, pedestrian bridge or signals) between non-similar uses (i.e., residential to commercial or office to commercial).
3. Any trip reduction rate based on the TDM program concept must include a concise binding plan/program and funding mechanisms for implementation of the proposed TDM program. Any study of a TDM program within the Washington metropolitan area, which is similar in nature to the proposed development, may be submitted to staff to assist them in evaluating the proposed TDM program prior to preparation of the TIA.

620.07 Future Traffic Conditions: The documented total future traffic in the report shall include the following:

- A. Background traffic, which may be calculated using one or both of the following techniques.
 1. Existing traffic adjusted by an annual growth rate factor and based on the design year(s), and the total estimated traffic generated at build-out of submitted and approved development plans within the designated study area; or
 2. Projected traffic volumes from approved regional or local traffic forecasting models.
- B. Estimated generated trips to and from the site.

620.08 Trip Distribution and Assignment:

- A. Any one of the following trip distribution and assignment methodologies shall be acceptable with the concurrence of staff. Justifications for trip generation and assignment shall be discussed and approved by staff at the pre-submission meeting. One of the following techniques shall be used:
 1. The gravity distribution model technique may be acceptable, but may require calibration prior to its use, particularly if utilizing an old gravity model for the study area.
 2. Metropolitan Washington Council of Government (MWCOC) latest trip assignments. Portions of MWCOC's trip assignment report related to the study area must be included in the TIA.
 3. Utilization of local and/or regional demographic data.

4. The current directional distribution based on observed traffic counts is acceptable if justification is provided indicating the directional distribution will not change before the design year, due to future changes in the land use or transportation system improvements.

B. Assignment of traffic to the network shall be in accordance with the agreed upon percentage distribution and type of transportation facility. The Director of Transportation shall approve and may provide recommendations prior to preparation of the report.

C. Inbound/outbound traffic may not always have similar distribution or assignments, therefore, the approach and/or departure routes may be different. The calculations for inbound/outbound traffic are subject to discussion and concurrence of the Director of Transportation.

D. The twenty-four (24) hour (daily) volume shall be distributed and assigned according to the method used for peak hour distribution and assignment.

620.09 Analysis:

A. Capacity analysis shall be performed for all intersections, streets, ramps, weaving sections, internal circulation and access points as identified in the TIA scoping meeting.

B. The latest version of the Highway Capacity Software (HCS) operational module shall be used. All worksheets indicating the inputs and outputs of the HCS program shall be presented in the study. Any deviation from the default values in the program must be proposed, documented and agreed to by the Director of Transportation.

C. If approved by the Director of Transportation, Highway Capacity Manual (HCM) "planning procedure" may be used for any proposed intersections being analyzed, subject to the evaluation of ten (10) years or more into the future.

D. A level of service (LOS) "D" or better is the minimum acceptable level of service on existing or planned freeway segments, interchanges, signalized/unsignalized intersections and ramp terminals, multi-lane, two-lane and urban roadways. A level of service "D" also must be maintained for the segment or link of roadways and all individual movements at all analyzed intersections.

E. A level of service (LOS) "C" or better is the minimum acceptable level of service for subdivision streets.

F. The Director of Transportation may require all intersections be analyzed for off-site/on-site queuing (i.e., queuing analysis to determine the length of a left and right-turn lane[s] and storage area[s]) to assess potential spill-back effects.

G. The TIA shall include a capacity analysis for all identified locations within the study area before and after each phase of the proposed development to determine the development's impact and necessary improvements.

H. If roadways and/or intersections within the study area are currently operating or are projected to operate under hazardous conditions or unacceptable levels of service, the improvements needed to mitigate the conditions shall be noted in the recommendations.

I. Use of any reserve capacity of a roadway or intersection resulting at a level of service "D" or below shall warrant recommendations in the study for future improvements.

J. On-site traffic circulation analysis may be included in the TIA. The analysis shall include, but not be limited to, major internal intersections, access points, travelways, and parking circulation and queuing analysis.

K. If required by the Director of Transportation, a progression analysis shall be performed for arterials having two or more signalized intersections within a mile of the proposed development. Transportation/traffic computer software or programs such as Synchro, HCS or SIDRA may be utilized for the analysis. Other software may be used when approved by the Director of Transportation.

L. Diagrams included in the study should include and identify the existing and proposed spacing(s) of all intersections/entrances and/or crossovers of divided roadways.

620.10 Recommendations:

A. At a minimum, the TIA shall include recommendations on the following items to mitigate the traffic impacts on the study area:

1. Widening and/or construction of roadways and intersections.
2. Intersection signalization, including but not limited to, signal warrant analysis, timing, phasing, and optimization and VDOT approved priority control equipment for Fire and Rescue.
3. Transportation demand management (TDM) programs which reduce the number of vehicle trips being generated by the proposed development.
4. Pedestrian, bicycle or transit facilities which reduce the number of vehicle trips being generated by the proposed development.
5. Transportation system management (TSM) techniques, such as traffic signal coordination, which optimizes the capacity of the transportation network.

B. The recommended improvements must be achievable. The DCSM, HCM, VDOT standards, and American Association of State Highway and Transportation Officials (AASHTO) manuals shall be utilized to design the recommended improvements. Whether or not the recommended improvements can be constructed shall not preclude acceptance of the TIA.

C. All recommended roadway improvements shall include the description, timing, funding, and source of the construction of said improvements.

D. A traffic impact analysis (TIA) which does not contain specific recommendations to mitigate any noted negative impacts shall not be considered complete.

630.00 TRANSPORTATION DEMAND MANAGEMENT (TDM)

630.01 What to include in a TDM:

A. A Transportation Demand Management (TDM) plan is a general plan of actions which is designed to change travel behavior in order to improve performance of transportation facilities and to reduce the need for additional road capacity. Methods may include but are not limited to the use of alternative modes, ride-sharing and vanpool programs, and other single-occupied vehicle (SOV) trip-reduction strategies. The TDM plan details mode choice not trip generation.

B. Any TDM plan not meeting the requirements of this section shall be considered incomplete and unacceptable.

C. A TDM plan submitted as part of a rezoning study will focus on site access, and off-site impacts. The primary focus of a TDM plan submitted with a site plan shall be site access, circulation and internal roads. However, the TDM Plan requirements may include but are not limited to the following strategies or any others:

1. Cycling/Pedestrian Improvements - If included, the applicant should proffer the provision of bicycle lanes and/or shared use paths along or adjacent to streets, which are consistent with the DCSM requirements including when the facilities will be operational and who will be responsible for construction and maintenance.
2. Multi-Modal Integration - If included, the TDM plan should address the integration of alternative modes of transportation within the existing and planned roadway network, as well as who will provide the alternative modes and when.
3. Guaranteed Ride Home (GRH) - If included, the applicant should address a guaranteed ride home program. The applicant shall provide receipts from taxis used in the GRH program periodically as a means of monitoring the effectiveness of this program.
4. Non-motorized Facilities - If included, the applicant should address the provision of non-motorized facilities including but not limited to walkways, sidewalks and courtyards, public paths, shared use paths, trails, and pedestrian streets linking residential and commercial components of the development independent of street layout.
5. Traffic Calming- If included, the applicant shall proffer traffic calming measures per PWC Residential Traffic Management Guide, such as median islands, raised crosswalks, roundabouts, etc., approved by the Director of Transportation which mitigate the additional impacts of the proposed development. The effectiveness of the applicant's traffic calming measures shall be included in the TDM.
6. Transit/Private Shuttle Improvements - If included, the applicant shall proffer transit and/or shuttle improvements which may include bus shelters, bus stop/pullouts, and other

transit/shuttle improvements, including who will provide, when operational, etc. as approved by the Director of Transportation during the scoping session.

7. Live/Work & Telecommuting - If included, the applicant should address the provision of surveying telecommuters and/or teleworkers periodically to measure the effectiveness of this program. An effective telecommute/telework program is defined as telecommuting from one to three days per week; how will the program be implemented; when will the program be operational; and who will be responsible for monitoring the program.

D. The applicant shall demonstrate how each strategy used in the TDM plan will be monitored periodically. The monitoring strategy must be discussed and approved by the Director of Transportation in the pre-submission meeting for the TDM plan.

1. A Transportation Management Association (TMA) shall be developed as the tool for measuring, quantifying and enforcing the strategies included in the TDM plan.

2. The applicant must show that the TMA will be established before construction can begin on the proposed development.

630.02 Administration:

A. A TDM plan shall conform to all of the provisions of this section unless the requirements of specific subsections are modified or deemed not necessary by the Director of Transportation as a result of the pre-submission meeting.

B. The applicant shall meet with the Director of Transportation prior to preparation of any TDM plan to determine the scope of the TDM plan (pre-submission/scoping meeting). All requirements for a TIA (Section 620.00 of this manual) must be met in addition to the additional criteria for a TDM plan.

C. Analysis: The TDM strategies should be analyzed for their impact on the adopted levels of service. The applicant shall analyze the TDM strategies used in the TDM plan to determine if the strategy improves the overall mode choice by reducing vehicle demand or by maximizing the person throughput of the system. The analysis shall also show if the TDM strategies reduce vehicle trips and/or vehicle miles traveled by encouraging alternative choices. The results of the TIA (Section 620.00) shall be included in the analysis and strategy recommendations of the TDM plan.

1. The latest version of highway capacity software (HCS) operational module, Florida Department of Transportation LOS standards or a highway transportation model equivalent, shall be used in the analysis when appropriate. All worksheets indicating the inputs and outputs of the HCS program shall be presented in the study. Any deviation from the default values in the program must be proposed, documented and agreed to by the Director of Transportation.

2. The TDM plan must be consistent with Metropolitan Washington Council of Government (MWCOC's) TDM program.

3. The TDM plan analysis shall show demographics by Traffic Analysis Zones (TAZs).
4. The TDM plan analysis shall provide travel behavior data with TDM strategies and without TDM strategies, including commute mode choice and average vehicle ridership.
5. The TDM plan analysis shall provide market information (i.e., surveys of potential participants) to help determine demand for potential new transportation services and the effects of possible transportation improvements, and to identify barriers and potential problems.
6. The TDM plan shall show achievement of at least 10 percent reduction in vehicle miles traveled (VMT) per capita over a 20-year period.

D. Recommendations and Implementation: The applicant shall recommend TDM strategies if the strategy improves the overall system level of service by reducing vehicle demand or by maximizing the person throughput (pedestrian network) of the system.

1. A TDM plan must be a concise binding plan/program with funding mechanisms for implementation of the proposed strategy. Any study of a TDM program within the Washington metropolitan area, which is similar in nature to the proposed development, may be submitted to staff to assist them in evaluating the proposed strategy prior to preparation on the TDM plan.
2. The recommended improvements must be achievable. The DCSM, HCM, VDOT standards, American Association of State Highway and Transportation Officials (AASHTO), as well as other known and acceptable standards, guides and manuals shall be utilized to design the recommended improvements.
3. All recommended TDM strategies shall include description, timing and funding for provision of said improvements.
4. The TDM plan recommendations must be enforceable by written agreement and approved.
5. A TDM plan which does not contain specific recommendations to mitigate any noted negative impacts (impacts which would be made upon the system if the applicant were not to do a TDM plan) shall not be considered complete.

E. Monitoring and Evaluation: Monitoring and evaluation will enable the County to determine how well TDM strategies are contributing to the TDM plan's goals and objectives. Through the monitoring and evaluation of TDM strategies, the applicant shall document and assess activities undertaken to implement and maintain the plan; assess the results of the program and achievement of plan's goals; spotlight activities that need improvement or added emphasis; and identify activities that are ineffective or inefficient.

1. The applicant shall demonstrate how each strategy used in the TDM plan will be monitored. The monitoring strategy and duration and frequency of strategy monitoring will need to be discussed and approved by the Director of Transportation in the pre-submission meeting for the TDM plan.
2. TDM strategies effectiveness will be assessed in two phases related to the time of implementation.
3. Short Term Measures: Number of vehicle trips reduced at the development site compared to the expected number generated without TDM strategies.
4. Long Term Measures: Reduction in vehicle delay (roadway segments) in areas around project sites compared to that expected without TDM strategies. Improvement in roadway LOS in areas around the project site compared to that expected without TDM strategies.
5. The applicant shall hold follow-up meetings with Transportation staff periodically after the implementation of the recommended strategy to assess the effectiveness of the strategy. If the applicant does not achieve the trip reductions from the implemented strategy as originally expected, the applicant shall address what will be done to reinforce the strategy.

640.00 TRANSPORTATION CONSTRUCTION AND INSPECTIONS

640.01 Comprehensive Inspection Program:

- A. In 1982 the Board of County Supervisors approved the adoption of the Comprehensive Inspection Program. The Program was developed to address the costs and the time delays associated with street inspection, testing, and acceptance of streets into the Secondary System of State Highways. The program allows Prince William County Department of Transportation Inspections to provide all inspections of public streets constructed by private development. This program is also referred to in the VDOT Subdivision Street Requirements, (SSR) as Comprehensive Subdivision Construction Inspection and in the VDOT Secondary Street Acceptance Requirements, (SSAR) as “Comprehensive Street Construction Inspection.” The year of plan approval should be used for document applicability.
- B. All streets inspected and tested under the Comprehensive Inspection Program must be constructed using methods which meet all applicable VDOT requirements. All provisions and/or agreements related to the Comprehensive Inspection Program must result in a quality road and the related processes must be equivalent to or greater than the documentation requirements contained within the VDOT Land Development Inspection Documentation Best Practices Manual.
- C. The use of independent testing laboratories and technicians for the purpose of testing materials is acceptable but must be approved.
- D. Laboratories and technicians must use VDOT approved methods and maintain VDOT approved certifications. Technicians, when testing onsite, must possess their certifications on their person at all times.

- E. Transportation Inspections shall provide direct oversight of testing by independent material technicians and laboratories, verifying that all testing is being performed in accordance with VDOT requirements including, but not limited to, the Materials Manual of Instruction, Road and Bridge Specifications, and Virginia Test Methods (VTM).
- F. Transportation Inspections shall require certifications of the quality of materials and verify that the manufacturers or producers of the materials are VDOT approved.

640.02 Pre-Construction:

- A. Prior to the release of a site development, early grading or any type of land disturbance permit, a Pre-Construction meeting must take place with the Department of Transportation Inspections and Department of Public Works Watershed Management Inspections.
- B. A Pre-Construction Package will be provided by the Department of Transportation Inspections at each Pre- Construction meeting. The representatives of the development are responsible for compliance of all parts of the Pre-Construction Package pertinent to their development. The development's representatives to the Pre-Construction meeting will sign for this document acknowledging receipt. This document and the approved plans will be kept onsite at all times.

640.03 Street Construction Inspection:

- A. All public streets will be inspected and tested as per the requirements of the Comprehensive Inspection Program and the VDOT Land Development Inspections Documentation Best Practices Manual.
- B. Prior to placement of aggregate, the developer's representative will contact the Transportation inspector to inspect the subgrade. The subgrade will be inspected by the review of all test results, string line, and proof rolled if required by the Transportation inspector. Placement of aggregate cannot occur until the Transportation inspector approves the subgrade.
- C. Prior to placement of base asphalt, the developer's representative will contact the Transportation inspector to schedule an inspection of the aggregate placed on the approved subgrade. The aggregate will be inspected by the review of test results and proof rolled if required by the Transportation inspector. Placement of base asphalt cannot occur until the Transportation inspector approves the aggregate.
- D. Prior to the placement of base and surface asphalt, the developer's representative will contact the Transportation inspector to schedule inspections of the asphalt placement and the testing by the technician. Prior to placement of the surface asphalt the base asphalt must be approved by the Transportation inspector.
- E. Placement of asphalt will meet or exceed the approved design depths.

- F. Open cut of asphalt for the placement of utilities is prohibited without prior approval from the Director of Transportation.

640.04 Special Agreements:

- A. Any item placed within the proposed or existing right of way dedicated or to be dedicated to public use and accepted into the Secondary System of State Highways and does not meet a VDOT standard must be identified during the plan review and approval process. Once identified it must be determined acceptable by the Transportation Department and VDOT to be allowed in the right of way by Special Agreement.
- B. Examples of non-standard items are landscaping, BMP and detention drainage structures, and retaining walls.
- C. Major utility crossings of streets to be accepted into the Secondary System of State Highways such as electric transmissions lines and petrochemical transmission lines will require a Subordination of Rights Agreement executed for street acceptance.

640.05 Street Acceptance:

- A. All streets proposed for public use and maintained by VDOT must be accepted into the Secondary System of State Highways.
- B. Streets eligible for acceptance must be inspected and tested under the Comprehensive Inspection Program.
- C. Prior to acceptance, the Board of County Supervisors must request by resolution that VDOT take the street into the Secondary System of State Highways for maintenance. Once the resolution has passed and the street paperwork package is approved by VDOT, a joint inspection of the street by Transportation inspectors and VDOT must occur. See the Pre-Construction Package for additional details on the street acceptance process.

TABLES

TABLE 6-1 TRIP GENERATION	
Dwelling Unit Type	Trip Generation (ADT)
Single-family Detached	10.1
Single-family Attached	8.7
Multifamily	6.4

TABLE 6-2 DESIGN SPEED FOR NEW STREETS	
Projected Average Daily Trips (ADT)	Design Speed mph
0 – 250	20
251 – 400	20
401 – 1,000	25
1,000 – 2,000	30
2,001 – 4,000	30
4,001 – 7,000	40
7,001 – 15,000	45
Over 15,000	50

Note: For Principal Arterials and Parkways, the design speed shall be sixty (60) mph.

TABLE 6-3 DESIGN SPEED FOR EXISTING STREETS	
Posted Speed mph	Design Speed mph
15	20
20	25
25	30
30	35
35	40
40	45
45	50
50	65
55	70

TABLE 6-4 STOPPING SIGHT DISTANCE						
Design Speed mph	Minimum Sight Distance ft.	K Value For		Desirable Sight Distance ft	K Value for	
		Crest Vertical Curve	Sag Vertical Curve		Crest Vertical Curve	Sag Vertical Curve
20	125	8	17	125	8	17
25	155	12	26	155	20	30
30	200	19	37	200	30	40
35	250	29	49	250	50	50
40	305	44	64	325	80	70
45	360	61	79	400	120	90
50	425	84	96	475	170	110
55	495	114	115	550	230	130
60	570	151	136	650	320	160

Note: When the roadway is on a grade, the stopping sight distance should take into consideration the braking distance and be adjusted or modified, as necessary, in accordance with AASHTO's and VDOT's latest guidelines. Height of eye = 3.5' and Height of object = 2.0'.

TABLE 6-5 INTERSECTION SIGHT DISTANCE (adopted 8-4-15)								
Design Speed mph	2-Lane Major Roadway feet		4-Lane Major Roadway (Undivided) and 4-lane divided at crossovers feet		4-Lane Major Roadway (Divided – 18' median) feet			
	Turn from Minor Road	Left Turn from Major Road	Turn from Minor Road		Left Turn from Major Road	Turn from Minor Road		Left Turn from Major Road
			SDL	SDR		SDL	SDR	
20	225	165	240	250	180	240	275	200
25	280	205	295	315	225	295	340	250
30	335	245	355	375	265	355	410	300
35	390	285	415	440	310	415	480	350
40	445	325	475	500	355	475	545	400
45	500	365	530	565	400	530	615	450
50	555	405	590	625	445	590	680	500
55	610	445	650	690	490	650	750	550
60	665	490	710	750	530	710	820	600

Note: The sight distance should be adjusted or modified for steep grade and wide median, as necessary, in accordance with AASHTO's and VDOT's latest guidelines. Height of eye = 3.5' and Height of object = 3.5'.

SDL = Sight Distance Left (vehicle making a right or left turn)
SDR = Sight Distance Right (vehicle making a left turn)
Sight Distance for left turn from major road is used to check the left-turn maneuver across opposing traffic.

TABLE 6-6 CROSSOVER SPACING		
Design Speed mph	Minimum Distance Between Crossovers feet	Desirable Distance Between Crossovers feet
35	500	600
40	600	700
45	650	800
50	700	900
55	800	1,000
60	900	1,100

TABLE 6-7 MINIMUM TURN LANE REQUIREMENTS		
Design Speed mph	Minimum Length Turn Lane feet	Minimum Length of Taper feet
30	150	100
35	200	100
40	200	100
45	250	100
50	350	100
55	400	100
60	500	100

*Additional storage length shall be provided on Minor and Principal Arterial roadways when determined necessary by VDOT and the County.

TABLE 6-8 REQUIRED LOADING AND OFF-STREET PARKING SPACES		
USE	LOADING	PARKING
RESIDENTIAL		#/ UNIT
Duplex		2 (exclusive of garage)
Age Restricted		1 per 3 units
Mobile home		2
Multifamily* efficiency/studio one-bedroom unit two or more bedroom units		1 1.5 2.2
* Subject to restrictive covenants prohibiting conversion of garage space to living/storage area.		
Multifamily, high-rise (buildings greater than 50ft. in height)	2 per building	1 per 10 units per building, plus:

**TABLE 6-8
REQUIRED LOADING AND OFF-STREET PARKING SPACES**

USE	LOADING	PARKING
efficiency studio one-bedroom unit two or more bedroom units		1 per unit 1.25 per unit 2 per unit
Single-family attached* Single-family attached with two or more car garage		2.75 (2 spaces per unit, plus 0.75 for every unit toward visitor parking; garage spaces may be counted*) 2.40 (2 spaces per unit, plus 0.4 for every unit toward visitor parking spaces; garage spaces may be counted*)
Single-family detached		2 (exclusive of garage)
NONRESIDENTIAL – Net Floor Area = 75% of Gross Floor Area		
Amusement or theme park	As deemed operationally necessary at the time of site plan review	- 1/200 net sq. ft. of building area, and - 1/20,000 net sq. ft of land area open to the public; or - an alternative standard, or number of spaces approved at the time of rezoning
Commercial kennel	1	1 per 500 net sq. ft.; 5 minimum
Cultural arts facilities, except theaters	1 up to 75,000 net sq. ft. then 1 per 100,000 net sq. ft.	1 per 400 net sq. ft.
Day-care facilities Adult – staff assistance Facilities Adult – senior citizen center ----- Child	1 1 ----- none; 1 bus turnaround area is to be provided	1 per 5 adults up to 40, then 1 per 10 based upon licensed capacity 1 per 200 net sq. ft. ----- 1 per 5 children up to 40 children, then 1 per 10 children, based upon licensed capacity
Farmer’s market	1 per 50,000 net sq. ft.; 2 minimum	1 per 400 net sq. ft. of sales area
Flea market	1 per 50,000 net sq. ft.; 2 minimum	1 per 200 net sq. ft.
Food store	1 up to 10,000 net. sq. ft., then 1 per 20,000 net sq. ft.	1 per 200 net sq. ft.; 10 minimum
Fraternal lodge/civic club	1	1 per 150 net sq. ft.

**TABLE 6-8
REQUIRED LOADING AND OFF-STREET PARKING SPACES**

USE	LOADING	PARKING
Garden Center/ greenhouse/nursery	1 per 50,000 net sq. ft. of interior floor area; 2 minimum	1 per 200 net. sq. ft. of indoor sales plus 1 per 1,000 net sq. ft. of outdoor and greenhouse sales (up to 100 spaces)
Heliport	1	10, plus 5 per tiedown
Helistop	none	5 per tiedown or pad
Home Improvement Center/hardware store	1, plus 1 per 30,000 sq. ft. including outside sales and storage.	1 per 200 net sq. ft. of indoor sales; plus 1 per 2,000 net sq. ft. outdoor sales and storage area.
Hospitals and other health service facilities		
Hospital – major surgical or short term visits	1 plus 1 per 75,000 net sq. ft.	1.25 per bed
----- Medical center, offices and clinics	1 up to 75,000 net sq. ft., then 2	1 per 150 net sq. ft. up to 15,000 net sq. ft., then 1 per 200 net sq. ft. up to 30,000 net sq. ft., then 1 per 250 net sq. ft. above 30,000 net sq. ft.
----- Nursing, convalescent or Personal care facility	1 up to 75,000 net sq. ft., then 2	1 per 2 beds, by licensed capacity
Hotels and motels (subject to additional loading and parking for ancillary uses)	1	1.2 per room
Libraries	1	1 per 125 net sq. ft.

**TABLE 6-8
REQUIRED LOADING AND OFF-STREET PARKING SPACES**

USE	LOADING	PARKING
Maritime uses Commercial or private marina	1	1 per 3 slips
----- Indoor storage facility	1	1 per 5 dry slips
----- Ramp or launching facility	none	10 car and trailer spaces
<i>Ancillary uses:</i>		
----- Retail, supplies and consumer items		1 per 400 net sq. ft.; 10 minimum
----- Restaurant	1 up to 10,000 net sq. ft. then 2 if greater than 10,000 net sq. ft.	1 per 75 net sq. ft.
----- Restaurant, (Snack bar, carry out, or other food service – not vending)	1	1 per 200 net sq. ft.
Mortuary funeral or wedding chapel	1	1 per 50 net sq. ft.; minimum 20
Motor Vehicle and related uses		
----- Indoor display area and offices	2 up to 75,000 net sq. ft., then 1 per 100,000 net sq. ft.	1 per 400 net sq. ft.
----- Outdoor sales area		1 per 5,000 net sq. ft. of sales area
----- Service area (work bays and waiting area)		3 per work or service bays
----- Retail parts and accessories sales area		1 per 300 net sq. ft.

**TABLE 6-8
REQUIRED LOADING AND OFF-STREET PARKING SPACES**

USE	LOADING	PARKING
<i>Heavy equipment sales and services</i>	1 per 25,000 net sq. ft.	
Indoor display area and offices		1 per 500 net sq. ft., minimum 5
Outside sales area		1 per 5,000 net sq. ft. of sales area
-----	-----	-----
Service area (work bays and waiting area)		2 per work bay
-----	-----	-----
Retail parts and accessories		1 per 300 net sq. ft.
-----	-----	-----
Additional Buildings		1 per 1,000 net sq. ft.
-----	-----	-----
<i>Recreational vehicle sales and services</i>	1 per 25,000 net sq. ft.	
Indoor display area and offices		1 per 400 net sq. ft.
-----	-----	-----
Outside sales area		1 per 2,500 net sq. ft. of sales area
-----	-----	-----
Service area (work bays and waiting area)		2 per work bay
-----	-----	-----
Retail parts and accessories		1 per 300 net sq. ft.
-----	-----	-----
<i>Retail fuel sales</i>		
Fuel only	1	5
-----	-----	-----
Fuel with service	1	1 per 200 net sq. ft. of office/retail area plus 3 per work bay; 10 minimum
-----	-----	-----
Fuel with convenience retail	1	5 plus 1 per 150 net sq. ft. of building area; 10 minimum

**TABLE 6-8
REQUIRED LOADING AND OFF-STREET PARKING SPACES**

USE	LOADING	PARKING
<p>Office, Financial Institutions</p> <hr/> <p>Office with ancillary retail or service uses</p>	<p>None for buildings with less than 20,000 net sq. ft. of building area; then 1 for each additional 20,000 net sq. ft. Maximum of 5 loading spaces for each building</p> <hr/> <p>1 per 20,000 net sq. ft. up to 100,000 net sq. ft., then 1 per 50,000 net sq. ft.</p>	<p>1 per 250 net sq. ft. of building area; 10 minimum</p> <hr/> <p>1 per 250 net sq. ft. plus 5%</p>
<p>Quick service food store</p>	<p align="center">1</p>	<p>1 per 150 net sq. ft. plus 2 up to 5,000 net sq. ft., plus 4 if greater than 5,000 net sq. ft.</p>
<p>Racetrack</p> <hr/> <p>Equestrian</p> <hr/> <p>Motorized vehicles</p>	<p>4, or as established by SUP</p> <hr/> <p align="center">4</p>	<p>1 per 2 seats plus 1 per 10 net sq. ft. of designated standing area, or as established by SUP</p> <hr/> <p>1 per 2 seats plus 1 per 10 net sq. ft. of designated standing area, plus 1 trailer space per work or service bay; 10 minimum</p>
<p>Recreational uses</p> <p><i>Commercial</i></p> <hr/> <p>Arcade</p> <hr/> <p>Billiard parlor</p> <hr/> <p>Bowling Alley</p> <hr/> <p>Alleys</p> <hr/> <p>Retail area</p> <p>Restaurant</p>	<p align="center">none</p> <hr/> <p>1, if sales facility is on premise</p> <hr/> <p>1, if sales facility or restaurant is on premise</p> <hr/>	<p>1 per 150 net sq. ft.</p> <hr/> <p>1 per 150 net sq. ft.</p> <hr/> <p>4 per lane</p> <hr/> <p>1 per 300 net sq. ft.</p> <p>1 per 400 net sq. ft. of restaurant area</p>

**TABLE 6-8
REQUIRED LOADING AND OFF-STREET PARKING SPACES**

USE	LOADING	PARKING
Court sports facility (single use)	none	4 per court plus 1 per 3 seats on stands
Fairground/carnival/ circus	4	1 per 400 net sq. ft. of area
Golf course and service facilities, single use	none	3 per hole
Miniature golf/driving range (single use)	none	2 per tee for the first 36 tees, then 1 per tee
Petting farms	none	1 per 20,000 net sq. ft. of the area open to the public
Pony rides/kiddie parks	none	1 per 20,000 net sq. ft. of the area open to the public
<i>Private recreational facility or club plus parking per the following uses</i>	1 if over 30,000 net sq. ft.	1 per 150 net sq. ft.
Restaurant, ancillary	1	1 per 200 net sq. ft.
Retail, ancillary	none	1 per 300 net sq. ft.
Active recreational uses (not courts or golf courses)	none	3 per acre
Hard or soft courts	none	4 per court
Regulation sports fields (softball, baseball, soccer, football, lacrosse, etc.)	none	30 per field
Swimming pools	1	1 per 150 sq. ft. of water surface area
<i>Public recreational facility/club</i>	1 if over 30,000 net sq. ft.	1 per 150 net sq. ft.

**TABLE 6-8
REQUIRED LOADING AND OFF-STREET PARKING SPACES**

USE	LOADING	PARKING
<i>plus parking per the following uses</i>		
Active recreational uses (not courts or golf courses)	none	3 per acre
----- Hard or soft courts	none	4 per court
----- Regulation sports fields (softball, baseball, soccer, football, lacrosse, etc.)	none	30 per field
----- Indoor uses (not pools or courts)	none	1 per 250 net sq. ft.
----- Passive recreation	none	3 per acre to 10 acres, then 1 per 10 acres; 10 minimum
----- Retail, ancillary to use	1 if over 10,000 net sq. ft.	1 per 300 net sq. ft.
----- Swimming pools	1	1 per 150 sq. ft. of water surface area
Religious institution (schools and offices - separate calculation)	None	1 per 3 seats or equivalent
Restaurants		
----- Freestanding	1 up to 10,000 net sq. ft. then 2 up to 30,000; then 3	1 per 100 net sq. ft.
----- Freestanding drive-in, drive-up, drive through or carryout	1 up to 10,000 net sq. ft.; then 2	1 per 75 net sq. ft., minimum 5 designated spaces
----- In-line (attached)	None up to 10,000 net sq. ft.; 1 up to 30,000	1 per 100 net sq. ft.

**TABLE 6-8
REQUIRED LOADING AND OFF-STREET PARKING SPACES**

USE	LOADING	PARKING
	net sq. ft.; then 1 per 50,000 net sq. ft.	
Retail sales and services and similar uses not specifically addressed including shopping centers	None up to 10,000 net sq. ft.; then 1 for up to 30,000 net sq. ft.; then 1 for up to 50,000 net sq. ft.; then 1 for up to 100,000 net sq. ft.; then 1 per 100,000 net sq. ft. after that	1 per 200 net sq. ft. up to 50,000 net sq. ft.; then 1 per 225 net sq. ft. up to 300,000 net sq. ft.; then 1 per 250 net sq. ft. after that.
School of special instruction, business or trade	none	1 per 200 net sq. ft.
Schools, public and private		
Learning Center	1	1/seat
----- Elementary or Middle Schools	2	1 space for every 20 classroom seats plus 5 visitor spaces, plus one space for every 5 seats in an auditorium or multipurpose room
----- High Schools	2	1 space for every 5 students, plus one per faculty member, plus 10 spaces for visitors, plus one space for every 4 seats in an auditorium or multipurpose room
----- Junior colleges, colleges, universities	2	1 space for every 5 classroom seats, plus 20 spaces for visitors, plus one space for every 3 seats in an auditorium or multipurpose room
Self-storage center	none	3.2 spaces per 1,000 net sq. ft. of office plus 1 space per employee and 2 spaces for the resident manager

Theater and other similar establishments	1	1 per 3.1 seats, by rated capacity
Veterinarian office, clinic or hospital Suburban/urban facility	1	1 per 200 net sq. ft.
----- Rural facility	----- 1	----- 1 per 400 net sq. ft.
INDUSTRIAL – Net Floor Area = 75% of Gross Floor Area		
Automobile Graveyard	2	1 per 200 net sq. ft., plus 4 per work bay; 20 minimum
General manufacturing	1 plus 1 per 40,000 net sq. ft.	1 per 1,000 net sq. ft.
Heavy industrial	1 plus 1 per 40,000 net sq. ft.	1 per 1,000 net sq. ft.
Maritime uses	none	1 per 500 net sq. ft. of office area, plus 10
Medical or dental laboratory	1 plus 1 per 50,000 net sq. ft.	1 per 300 net sq. ft. to 10,000 net sq. ft., then 1 per 500 net sq. ft.
Research and development	1 plus 1 per 50,000 net sq. ft.	1 per 300 net sq. ft. to 10,000 net sq. ft.; then 1 per 500 net sq. ft.
Warehouse and wholesaling	1 plus 1 per 40,000 net sq. ft.	1 space per employee, plus 5 spaces
If office space exceeds fifty (50) percent of net floor area	none	1 per 300 net sq. ft. up to 100,000 net sq. ft.; then as provided above

TABLE 6-9 PUMP ISLAND SETBACK	
Angle of Pump Island to ROW (degrees)	Setback feet
Parallel	12*
1 to 45	20
45 to 90	30
*The setback shall be twenty-two (22) feet if refueling area is provided on the side of the pump island closest to the right-of-way.	

TABLE 6-10 MINIMUM OFF-STREET PARKING AREA DIMENSIONS					
Angle of Parking degrees	Width of Stall (feet)	Depth of Stall Perpendicular to Aisle (feet)	Width of Aisle (feet)	Width of Aisle Plus Two Stalls (feet)	Width of Stall Parallel to Aisle (feet)
(Universal Car Space)					
45	9.0	19.1	*15.5	53.7	12.7
60	9.0	20.0	*17.0	57.0	10.4
90	9.0	18.0	**22.0	58.0	9.0
(Compact Cars)					
90	8.0	16.0	22.0	54.0	8.0
* One-way					
**Two-way (Angled parking less than 90° is not permitted with two-way travelway)					

TABLE 6-11 PARALLEL PARKING AND AISLE DIMENSIONS			
Direction of Traffic	Width of Stall Feet	Depth of Stall feet	Width of Aisle
One-way aisle (One-side parking)	9.0	22.0	12.0
One-way aisle (Two-side parking)	9.0	22.0	15.0
Two-way aisle (Two-side parking)	9.0	22.0	22.0

**TABLE 6-12
TIA GUIDELINES FOR STUDY DESIGN YEAR HORIZONS**

Development Characteristic	Suggested Horizons
1. Single-phase development (<500 peak hour trips)	1. Anticipated opening year, assuming full build-out and occupancy.
2. Single-phase development (500 – 1,000 peak hour trips)	1. Anticipated opening year, assuming full development build-out and occupancy. 2. Five years after opening date.
3. Single-phase development (>1,000 peak hour trips)	1. Anticipated opening year, assuming full build-out and occupancy. 2. Five years after full build-out and occupancy. 3. Adopted transportation plan horizon year if the development is significantly larger than that included in the adopted Comprehensive Plan or travel forecasts for the area.
4. Multiple-phase development (when ultimate road improvements are proposed to be phased)	1. Anticipated opening years of each major phase, assuming build-out and full occupancy of each phase. 2. Anticipated year of complete build-out and occupancy. 3. Adopted transportation plan horizon year if the development is significantly larger than that included in the adopted plan or travel forecasts for the area. 4. Five years after opening date if completed by then and there is no significant trip generation increase from adopted Comprehensive Plan or area transportation forecasts (e.g., at least 15%)
Note: Peak hour trips based on the ITE Trip Generation Manual	

**TABLE 6-13
Bike Parking for Specific Land Uses**

Use	Bicycle Parking Spaces Requirements*
Multi-Family Residential	One Space/10 Units
Commercial Retail	One employee space/10,000 square feet of floor area.
Office	One employee space/10,000 square feet of floor area
Industrial	One employee space/25,000 square feet of floor area
Institutional Uses Libraries, Schools (including colleges and universities) Government Facilities	To be determined in consultation with the Prince William County Public Schools and the Prince William County Department of Transportation.
Note: Bicycle parking is a defined space or facility set aside for storing bicycles, including bike racks, striped pavement and bike lockers.	

650.00 TRANSPORTATION SYSTEMS - DETAILS

650.61 SLI Typical Street Light Installation

The notes on the light pole diagram, which are shown on Detail No. 650.61, will also be changed to reflect this VDOT amendment.

TABLE II PAVEMENT STRUCTURE DESIGN

CATEGORY	SUBBASE	BASE	SURFACE TYPE SM-9.5A
UP TO 250 VPD I	1. N/A	6 inches Agg. Base Material	2 inches Asph. Conc
	2. 4 inches (Select Material Type I, II or III)	4 inches Agg. Base Material	2 inches Asph. Conc
251 TO 400 VPD II	1. N/A	8 inches Agg. Base Material	2 inches Asph. Conc
	2. 6 inches Agg. Subbase or Base Material	3 inches Asph. Conc Type BM-25.0A	2 inches Asph. Conc
401 TO 1,000 VPD III	1. 8 inches Agg. Subbase or Base Material	3 inches Asph. Conc Type BM-25.0A	1-1/2 inches Asph. Conc
	2. 6 inches Cement Treated Aggregate	3 inches Asph. Conc Type BM-25.0A	2 inches Asph. Conc
	3. 8 inches Agg. Subbase or Base Material	4 inches Asph. Conc Type BM-25.0A	2 inches Asph. Conc
1,001 TO 2,000 VPD IV	1. 6 inches Cement Treated Aggregate	6 inches Agg. Base Material	2 inches Asph. Conc
	2. 8 inches Agg. Subbase or Base Material	4 inches Asph. Conc Type BM-25.0A	2 inches Asph. Conc
	3. 8 inches Agg. Subbase or Base Material	6 inches Asph. Conc Type BM-25.0A	1-1/2 inches Asph. Conc
2,001 TO 4,000 VPD V	1. 6 inches Cement Treated Aggregate &	3 inches Asph. Conc Type BM-25.0A	1-1/2 inches Asph. Conc
	5 inches Agg. Subbase or Base Material	5 inches Asph. Conc Type BM-25.0A	1-1/2 inches Asph. Conc
	8 inches Agg. Subbase or Base Material	6 inches Asph. Conc Type BM-25.0A	2 inches Asph. Conc
4,001 TO 7,000 VPD VI	1. 8 inches Agg. Subbase or Base Material	7 inches Asph. Conc Type BM-25.0A	2 inches Asph. Conc
	2. 8 inches Agg. Subbase or Base Material	8 inches Asph. Conc Type BM-25.0A	2 inches Asph. Conc
	3. 6 inches Cement Treated Aggregate	5 inches Asph. Conc Type BM-25.0	2 inches Asph. Conc
7,001 (PLUS) VPD VII*	1. 6 inches Cement Treated Aggregate	4 inches Asph. Conc Type BM-25.0A	1-1/2 inches A.C.
	2. 8 inches Agg. Subbase or Base Material	and 2 inches Asph. Conc. Type IM-19.0A	(SM-9.5D)
		9 inches Asph. Conc Type BM-25.0A	1-1/2 inches Asph. Conc

*For traffic volumes over 10,000 vehicles per day, use SM-9.5D for surface course.

Detail No. 650.01	SPD-1	 COUNTY OF PRINCE WILLIAM VIRGINIA	STANDARD PAVEMENT DESIGN (SHEET 1 OF 3)	Date 7/15/14
-----------------------------	--------------	--	--	-----------------

GENERAL NOTES:

1. When the projected traffic requires a four lane facility, 80% of the projected traffic shall be the basis for determining the applicable class for the pavement structure design.
2. Subgrade support soils, immediately under the pavement, with CBR values of less than ten will require an additional six (6) inches of subbase or base. In lieu of this, the CBR value may be improved by any other acceptable means. In any case, the subbase aggregate shall not exceed twelve (12) inches.
3. Sufficient engineer certified CBR tests must be run to determine the soil support value (SSV) of the various soils in the subgrade. Details to the VDOT approved method may be obtained through any VDOT District or Residency Office or its Central Office.
4. Pavement design in accordance with "Pavement Design Guide of Subdivision and Secondary Roads in Virginia" of VDOT is acceptable an alternate to any of the above.
5. Each street should have continuity of design throughout. Therefore, multiple and/or variable base design will only occur at the intersections.
6. Designs within a specific traffic category may not be structurally equal because of differences in the materials' flexural strengths and practical construction consideration.
7. Cement Treated Aggregate (CTA) or full depth Bituminous Concrete can be substituted for any aggregate, subgrade stabilization, or select material on a basis of one (1) inch of CTA or Bituminous Concrete for two (2) inches of the other materials. Neither CTA nor Bituminous Concrete should be placed directly on a resilient soil unless the soil is stabilized with cement or other stabilizing agent. CTA should have a minimum of four (4) inches of aggregate material under it when less than four (4) inches of bituminous concrete is used on top of the CTA.
8. UD-1's must be used with high water tables. UD-2's must be used for all pavement sections with grassed medians.
9. Subsurface and pavement drainage problems must be corrected in accordance with current VDOT standards.
10. The pavement designs in the tables are based on an assumed CBR value of 10 and are recommended as a guide. The actual designs shall be based upon the traffic volume and CBR values for specific projects.
11. Categories IV thru VII or any street intended to carry a design traffic volume exceeding 1,000 VPD shall utilize 21B aggregate as subbase or base material. Pavement drainage, such as the use of underdrains, should be provided in the pavement design when 21B aggregate is used.

Detail No.	SPD-1		COUNTY OF PRINCE WILLIAM VIRGINIA	STANDARD PAVEMENT DESIGN (SHEET 2 OF 3)	Date 7/15/14
650.01					

GENERAL NOTES (continued):

12. The maximum combined thickness of subbase and base layers of aggregate materials shall be twelve (12) inches. Any thickness index that requires an aggregate layer over twelve (12) inches should be developed through appropriate treatment of subgrade or through the use of thicker asphalt concrete layers.
13. Plain aggregate should be primed with liquid asphalt material in accordance with VDOT specifications whenever Four (4) inches or less of asphalt is to be placed on a plain or cement stabilized aggregate.
14. Paved shoulders, where required, should be designed in accordance with VDOT standards and specifications.
15. Superpave mixes when required by Department of Transportation and VDOT, shall be designed in accordance with the minimum requirements of VDOT and this manual. Pavement layers thickness design, material requirements, mix design criteria, job mix formula and specifications shall be in accordance Section 211 of VDOT Road and Bridge Specifications Manual and current Special Provisions.

Detail No.	SPD-1		COUNTY OF PRINCE WILLIAM VIRGINIA	STANDARD PAVEMENT DESIGN (SHEET 3 OF 3)	Date 7/15/14
650.01					

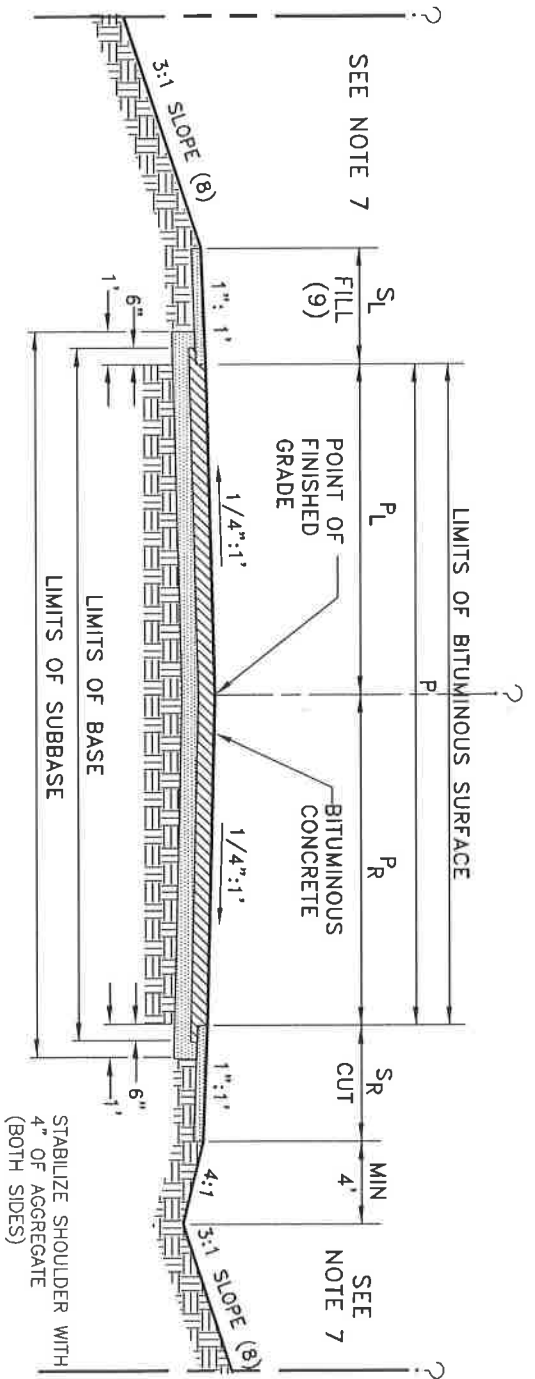

CATEGORY	TRAFFIC VOLUME (VPD)	R.O.W. WIDTH (ft.)	DESIGN SPEED (mph)	MAX GRADE	MIN. C.L. RADIUS (ft.)(10)	MIN. SIGHT DISTANCE STOP INTX (ft.)	S _L (ft)	P _L (ft)	P (ft)	P _R (ft)	S _R (ft)	TYPE I SUBBASE (BM-25.0A)	BASE (SM-9.5A)	SURFACE
I (4)	UP TO 250	42	20	10%	120	125	4	9	18	9	4	6 in		2 in
II	251 TO 400	44	20	10%	120	125	5	10	20	10	5	8 in		2 in
III	401 TO 1,000	56	25	10%	200	155	6	11	22	11	6	8 in	4 in	2 in

GENERAL NOTES:

- This typical cross section shall be used in all subdivisions considered as rural/semi-rural, (subdivisions where average lot size is one (1) acre or greater.)
- Standard landings required at intersections.
- Pavement section is standard requirement. Refer to Detail 650.01 for alternative pavement sections.
- Forty foot (40 ft.) right-of-way allowed in certain circumstances where all slopes and drainage structures can be included and the average lot size is five (5) acres or more and approved by the Director of Transportation and VDOT.
- Off street parking shall be required in accordance with Section 610.02 of this manual.
- Travelways or roadways serving large lot subdivisions shall be designed conforming to VDOT and/or County requirements whichever is more stringent.
- Additional right-of-way shall be required if streetscapes and shared use paths are required.
- 2:1 slopes will be allowed when soil type supported by soil report is acceptable and where special stabilization in accordance with Erosion Control ordinance is provided.
- Wider shoulder shall be required in accordance with VDOT standards where guardrails are provided.
- Minimum radius applies to level and rolling terrains.
- Changes in categories, where permitted, shall be at intersections only and to the next lower or higher category only.
- Sidewalk or shared use path is required per VDOT Secondary Street Acceptance Requirements.

Detail No.	RL-1	 <p style="margin: 0;">COUNTY OF PRINCE WILLIAM VIRGINIA</p>	<p style="margin: 0;">STANDARD TYPICAL SECTION FOR RESIDENTIAL LOCAL STREETS WITHOUT CURB AND GUTTER (FIXED TRAFFIC)</p>
650.02			Date 7/15/14

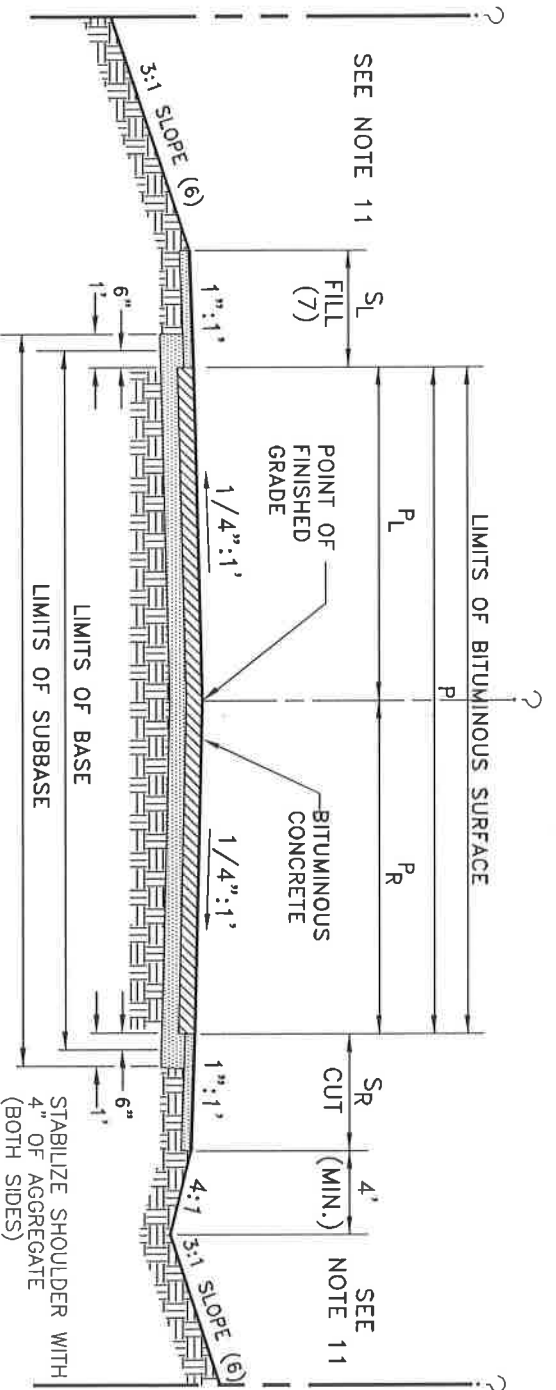

CATEGORY	TRAFFIC VOLUME (VPD)	R.O.W. WIDTH (ft.)	DESIGN SPEED (mph)	MAX GRADE	MIN C.L. RADIUS (ft.)	MIN. SIGHT DISTANCE STOP INTX (ft.)	S _L (ft)	P _L (ft)	P (ft)	P _R (ft)	S _R (ft)	TYPE 1 SUBBASE AGG. BASE (21-B)	BASE (BM-25.0A) (SM-9.5A)	SURFACE (SM-9.5A)
IV	1,001 TO 2,000	56	30	10%	335	225	8	11	22	11	6	8 in	6 in	1.5 in
V	2,001 TO 4,000	60	30	10%	335	225	9	12	24	12	8	8 in	6 in	2 in
VI	4,001 TO 7,000	62	40	9%	762	305	9	12	24	12	9	8 in	8 in	2 in

GENERAL NOTES:

- This typical cross section shall be used in all subdivisions considered as rural/semi-rural (subdivisions where average lot size is one (1) acre or greater).
- Standard landings required at intersections.
- No parking or direct residential access permitted on Category VI.
- Pavement section is standard requirement. Refer to Detail 650.01 for alternative pavement sections.
- Superlevation shall be provided only for Category VI streets. Consider superlevation rate of 2.08%.
- 2:1 slopes will be allowed when soil type supported by soil report is acceptable and where special stabilization in accordance with the Erosion Control ordinance is provided.
- Wider shoulder shall be required in accordance with VDOT standards where guardrails are provided.
- Six (6) foot ditch is only applicable to CAT VI Roadway.
- Channelized intersections will be required at all intersections of existing or future Category VI streets.
- Off street parking shall be required in accordance with Section 610.02 of this manual.
- Additional right-of-way may be required if streetscape and shared use paths are required.
- Sidewalk or shared use path is required per VDOT Secondary Street Acceptance Requirements.

Detail No.	COUNTY OF PRINCE WILLIAM VIRGINIA		STANDARD TYPICAL SECTION FOR RESIDENTIAL MINOR COLLECTOR STREETS WITHOUT CURB AND GUTTER	Date 7/15/14
650.03	RM-1			

CATEGORY	TRAFFIC VOLUME (VPD)	R.O.W. WIDTH (ft.)	DESIGN SPEED (mph)	MAX GRADE	MIN C.L. RADIUS (ft.)	MIN. SIGHT DISTANCE STOP (ft.)	S _L (ft)	P (ft)	S _R (ft)	TYPE 1 SUBBASE AGG. BASE (21-A)	BASE (BM-25.0A)	SURFACE (SM-9.5A)
I	UP TO 250	54	20	10%	120	125	225	15	24	6 in		2 in
II	251 TO 400	54	20	10%	120	125	225	15	24	8 in		2 in
III	401 TO 1,000	62	25	10%	200	155	280	15	32	8 in		2 in

GENERAL NOTES:

- This typical cross section shall be used in all subdivisions considered as urban/suburban (subdivisions where average lot size is less than one (1) acre).
- Standard landings required at intersections.
- Stone material shall extend under the curb and gutter a minimum of six inches (6 in.) beyond the back of curb. The stone thickness under the curb and gutter shall be that in excess of the depth of the gutter face or a minimum of four inches (4 in.) whichever is greater.
- Category I applies to permanent cul-de-sacs only.
- Changes in categories, where permitted, shall occur at intersections only and to the next lower or higher category only.
- 2:1 slopes will be allowed when soil type supported by soil report is acceptable and where stabilization is provided in accordance with the Erosion Control ordinance.
- Sidewalks shall be provided in accordance with Section 602.18.
- Pavement section is standard requirement. Refer to Detail 650.01 for alternative pavement sections.
- No super-elevation is required.
- Category I and II streets shall require an additional two feet (2 ft.) of pavement and right-of-way when total roadway length is one-half (0.5) mile or more.
- If optional street tree plantings are not provided per Section 802.46, the right-of-way may be reduced by 5 feet.

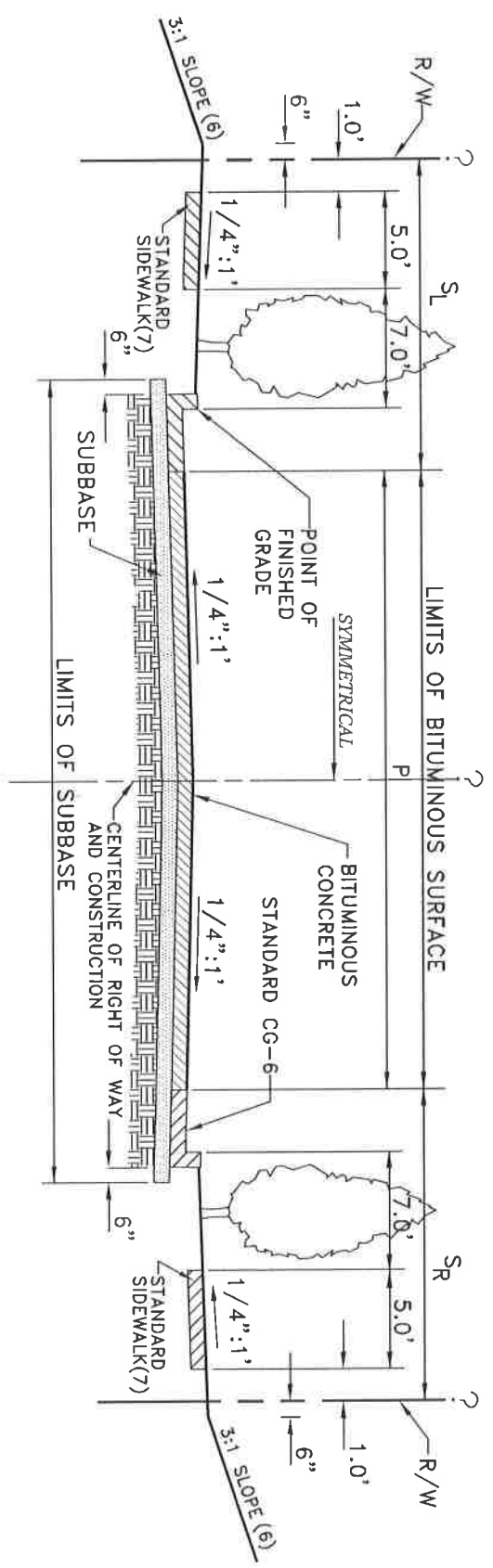

Detail No.	RL-2		COUNTY OF PRINCE WILLIAM VIRGINIA	STANDARD TYPICAL SECTION FOR RESIDENTIAL LOCAL STREETS WITH CURB AND GUTTER (FIXED TRAFFIC)	Date 7/15/14
650.04					

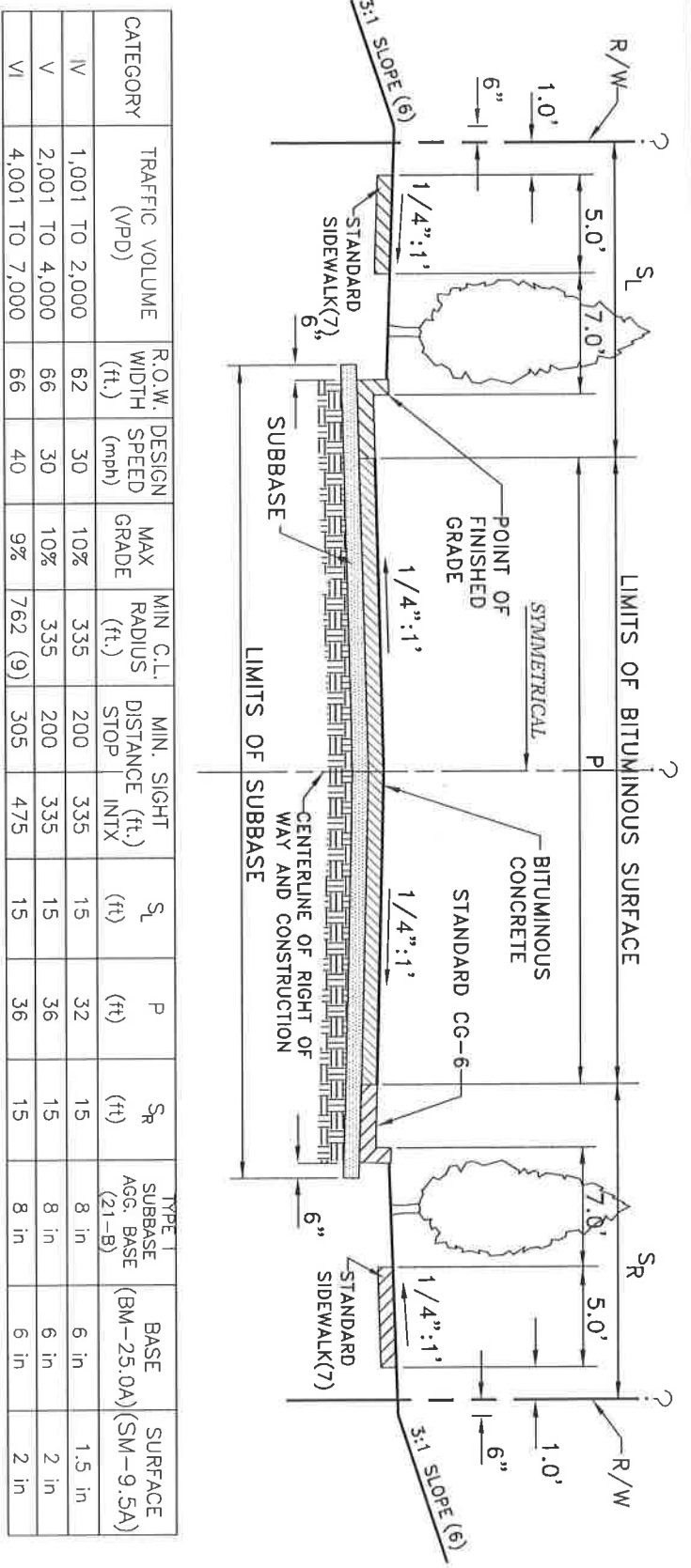

CATEGORY	TRAFFIC VOLUME (VPD)	R.O.W. WIDTH (ft.)	DESIGN SPEED (mph)	MAX GRADE	MIN. C.L. RADIUS (ft.)	MIN. SIGHT DISTANCE STOP (ft.)	S _L (ft)	P (ft)	S _R (ft)	TYPE 1 SUBBASE AGG. BASE (21-B)	BASE (BM-25.0A) (SM-9.5A)	SURFACE (SM-9.5A)
IV	1,001 TO 2,000	62	30	10%	335	200	335	15	32	15	6 in	1.5 in
V	2,001 TO 4,000	66	30	10%	335	200	335	15	36	15	6 in	2 in
VI	4,001 TO 7,000	66	40	9%	762 (9)	305	475	15	36	15	6 in	2 in

GENERAL NOTES:

1. This typical cross section shall be used in all subdivisions considered as urban/suburban (subdivisions where average lot size is less than one (1) acre).
2. Standard landings required at intersections.
3. Stone material shall extend under the curb and gutter a minimum of six inches (6 in.) beyond the back of curb. The stone thickness under the curb and gutter shall be that in excess of the depth of the gutter face or a minimum of four inches (4 in.) whichever is greater.
4. Reduction in categories, where permitted, shall occur at intersections only and to the next lower or higher category only.
5. No parking or direct residential access permitted on Category VI.
6. 2:1 slopes will be allowed when soil type supported by soil report is acceptable and where special stabilization is provided in accordance with the Erosion Control ordinance.
7. Sidewalks shall be provided in accordance with Section 602.18.
8. Pavement section is standard requirement. Refer to Detail 650.01 for alternative pavement sections.
9. Superlevation shall be provided for only Category VI streets. Consider superlevation rate of 2.08%.
10. Channelized intersections will be required at all intersections of existing and future Category VI streets.
11. Off street parking shall be required in accordance with Section 610.02.
12. If optional street tree plantings are not provided per Section 802.46, the right-of-way may be reduced by 5 feet.

Detail No.	RM-2		COUNTY OF PRINCE WILLIAM VIRGINIA	STANDARD TYPICAL SECTION FOR RESIDENTIAL MINOR COLLECTOR STREETS WITH CURB AND GUTTER	Date
650.05					7/15/14

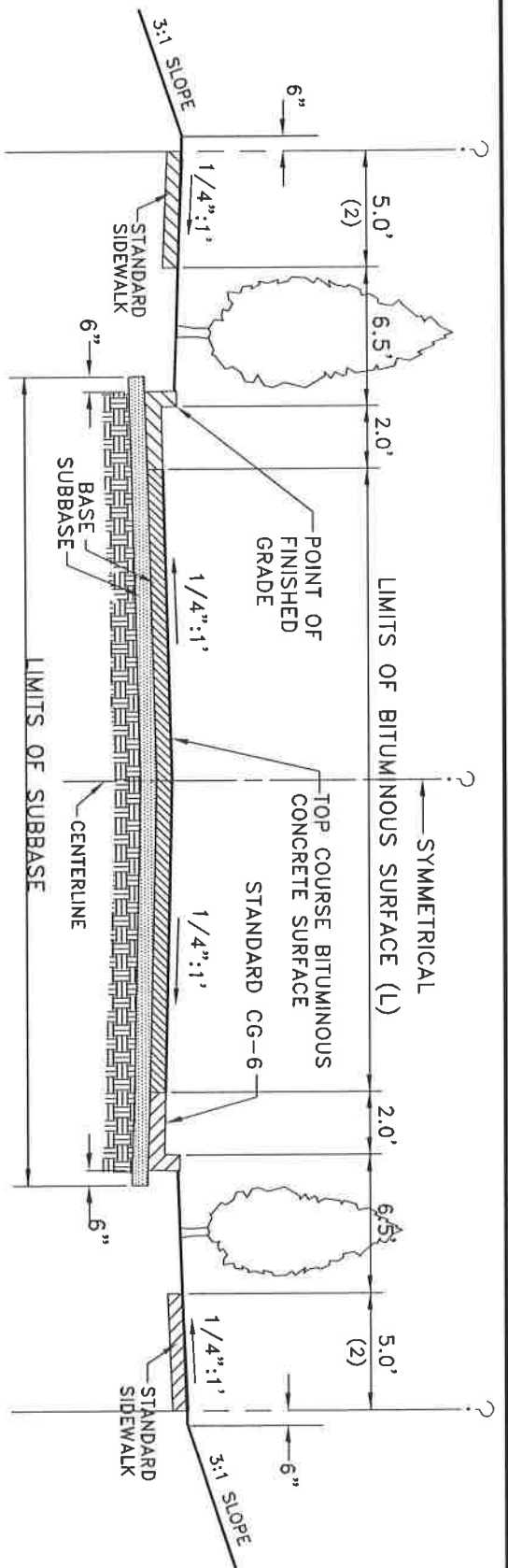

TRAFFIC VOLUME (VPD)	PARKING	L	PAVEMENT SECTION
0 TO 250	No Parking Allowed	22 ft	CATEGORY I
0 TO 250	Parallel (one side)	30 ft	CATEGORY I
0 TO 250	Parallel (both sides)	36 ft	CATEGORY I
0 TO 250	Perpendicular	22 ft (1)	CATEGORY I
251 TO 400	Perpendicular (both sides)	24 ft (1)	CATEGORY II
251 TO 400	No Parking Allowed	22 ft	CATEGORY II
401 TO 600	Parallel (one side)	30 ft	CATEGORY III
401 TO 600	Perpendicular	24 ft (1)	CATEGORY III
601 TO 1000	No Parking Allowed	24 ft	CATEGORY III

GENERAL NOTES:

1. These dimensions are for travelways only, exclusive of parking spaces.
2. Sidewalk location to be determined during final site plan review.
3. Stone material shall be extended under the curb and gutter a minimum of six inches (6 in.), beyond the back of curb. The aggregate thickness under the curb and gutter shall be in excess of the depth of the gutter face or a minimum of four inches (4 in.), whichever is greater.
4. Refer to Detail 650.01 for alternative pavement sections.
5. Maximum grade eight percent (8%).
6. Design of this type of roadway shall conform to current VDOT requirements.
7. If optional street tree plantings are not provided per Section 802.46, the right-of-way may be reduced by 5 feet.

Detail No.	TS-1		COUNTY OF PRINCE WILLIAM VIRGINIA	TRAVELWAY STANDARDS FOR INDUSTRIAL, INSTITUTIONAL, OFFICE, COMMERCIAL, SINGLE FAMILY ATTACHED, AND MULTIFAMILY DEVELOPMENTS	Date
650.06					7/15/14

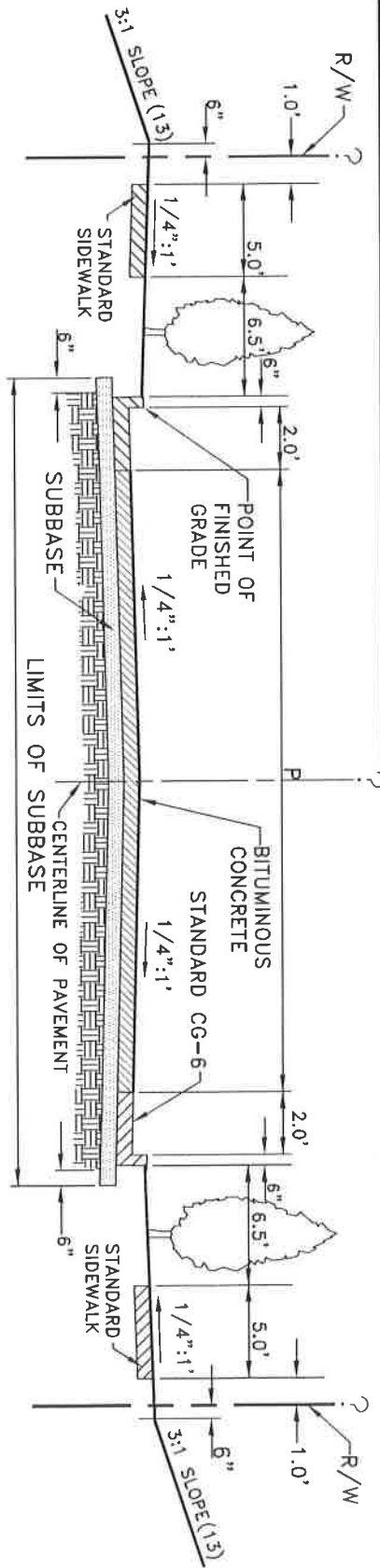

CATEGORY	TRAFFIC VOLUME (VPD)	R.O.W. WIDTH (ft.)	DESIGN SPEED (mph)	MAX GRADE	MIN. C.L. RADIUS (ft.)	MIN. STOP DISTANCE (ft.)	SIGHT INTX (ft.)	P (ft)	TYPE I SUBBASE AGG. BASE	BASE (BM-25.0A) (SM-9.5A)	SURFACE
I	UP TO 250	50	20	10%	120	125	225	20	6 in		2 in
II	251 TO 400	50	20	10%	120	125	225	20	8 in		2 in
III	401 TO 1,000	56	25	10%	200	155	280	26	8 in	4 in	2 in
IV	1,001 TO 2,000	56	30	10%	335	200	335	26	8 in	6 in	1.5 in
V	2,001 TO 4,000	56	30	10%	335	200	335	26	8 in	6 in	2 in

GENERAL NOTES:

1. This typical cross section shall be used only for multifamily developments (not for mixed use developments).
2. No residential frontage permitted.
3. No parking permitted. "No Parking" signs shall be installed.
4. Stone material shall extend under the curb and gutter, a minimum of six inches (6 in.) beyond the back of curb. The stone thickness under the curb and gutter shall be that in excess of the depth of the gutter face or a minimum of four inches (4 in.), whichever is greater.
5. A barrier or barricade must be installed between adjoining parking bays and the dedicated right-of-way to prevent parked vehicles from overhanging the right-of-way.
6. Distinct cur-de-sacs must be constructed where streets end and travelways or parking bays begin.
7. Changes in categories, where permitted, shall occur at intersections only and to the next lower or higher category only.
8. Standard landings required at intersections.
9. Pavement section is standard requirement. Refer to Detail 650.01 for alternative pavement sections.
10. Category I and II streets shall require an additional two (2 ft.) of pavement and right-of-way when the total street length is one half (0.5) mi. or more.
11. No superelevation is required.
12. 2:1 slopes will be allowed when soil type supported by soil report is acceptable and where stabilization is provided in accordance with the Erosion Control ordinance.
13. Sidewalks shall be provided in accordance with Section 602.18.
14. If optional street tree plantings are not provided per Section 802.46, the right-of-way may be reduced by 5 feet.

Detail No.	MF-1	<p style="margin: 0;">COUNTY OF PRINCE WILLIAM VIRGINIA</p>	<p style="margin: 0;">STANDARD TYPICAL SECTION FOR CONDOMINIUM, MOBILE HOME, AND APARTMENT STREETS WITH NO RESIDENTIAL FRONTAGE</p>
650.07			Date 7/15/14

CATEGORY	TRAFFIC VOLUME (VPD)	R.O.W. WIDTH (ft.)	DESIGN SPEED (mph)	MAX GRADE	MIN. C.L. RADIUS (ft.)	MIN. SIGHT DISTANCE STOP (ft.)	S _L (ft)	P (ft)	S _R (ft)	TYPE I SUBBASE AGG. BASE	BASE (BM-25.0A) (SM-9.5A)	SURFACE
IV	0 TO 1,500	62	30	9%	335	200	15	32	15	8 in	6 in	1.5 in
V	1,501 TO 4,000	66	30	9%	335	200	15	36	15	8 in	6 in	2 in
VI (7)	4,001 TO 7,000	74(10)	40	8%	762	305	15	44 (10)	15	8 in	8 in	2 in

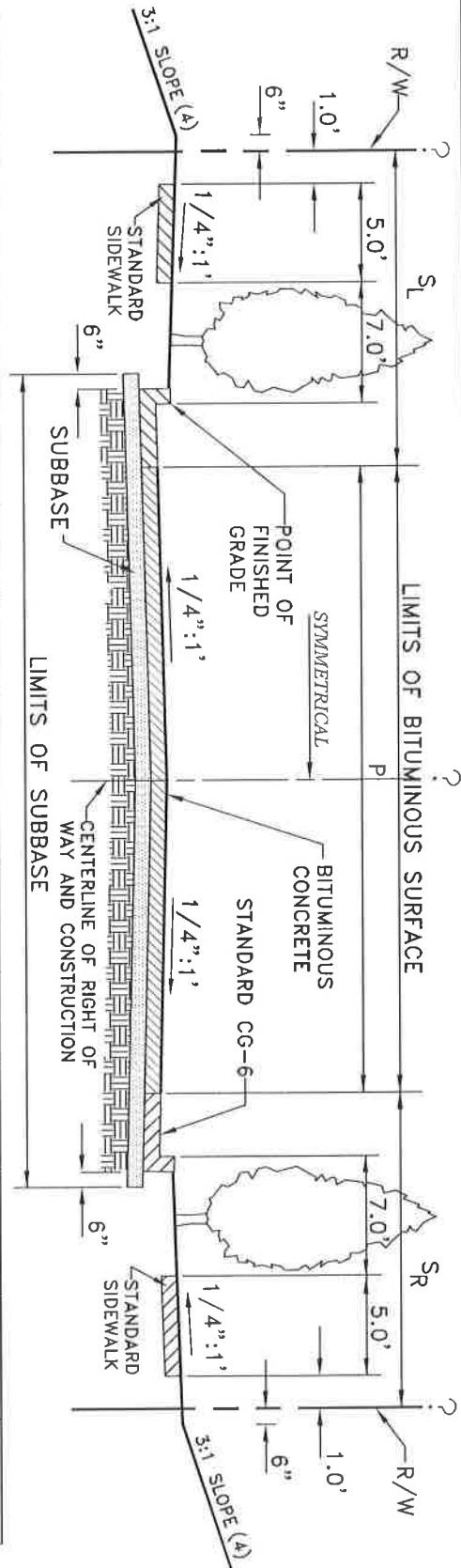

GENERAL NOTES:

- This typical cross section shall be used only for all streets within commercial and industrial areas.
- No parking allowed along curb.
- Stone material shall extend under the curb and gutter a minimum of six inches (6 in.) beyond the back of curb. The stone thickness under the curb and gutter shall be that in excess of the depth of the gutter face or a minimum of four inches (4 in.) whichever is greater.
- 2:1 slopes will be allowed when soil type supported by soil report is acceptable and where stabilization is provided in accordance with the Erosion Control ordinance.
- Standard landings required at intersections.
- Minimum cul-de-sac radius is 50 ft. to face of curb.
- Major intersections may require channelization on Category VI streets.
- Pavement section is standard requirement. Refer to Detail 650.01 for alternative pavement sections.
- Superelevation shall be provided for Category VI street in accordance with the current VDOT Road and Bridge Standards for Urban Low-Speed Roadways.
- ROW and P values may be reduced to seventy feet (70 ft.) and forty feet (40 ft.), respectively, if the proposed street is a permanent cul-de-sac or loop.
- If optional street tree plantings are not provided per Section 802.46, the right-of-way may be reduced by 5 feet.
- SDL, Sight Distance Left (for a vehicle looking left and making a right or left turn) = 475'. SDR, Sight Distance Right (for a vehicle looking right and making a left turn) = 500'. Otherwise, use latest VDOT or ASSHTO standards, whichever is more stringent.

Detail No.

650.08

C1-1



COUNTY OF
PRINCE WILLIAM
VIRGINIA

STANDARD TYPICAL SECTION FOR
COMMERCIAL AND INDUSTRIAL STREETS
WITH CURB AND GUTTER

Date
7/15/14

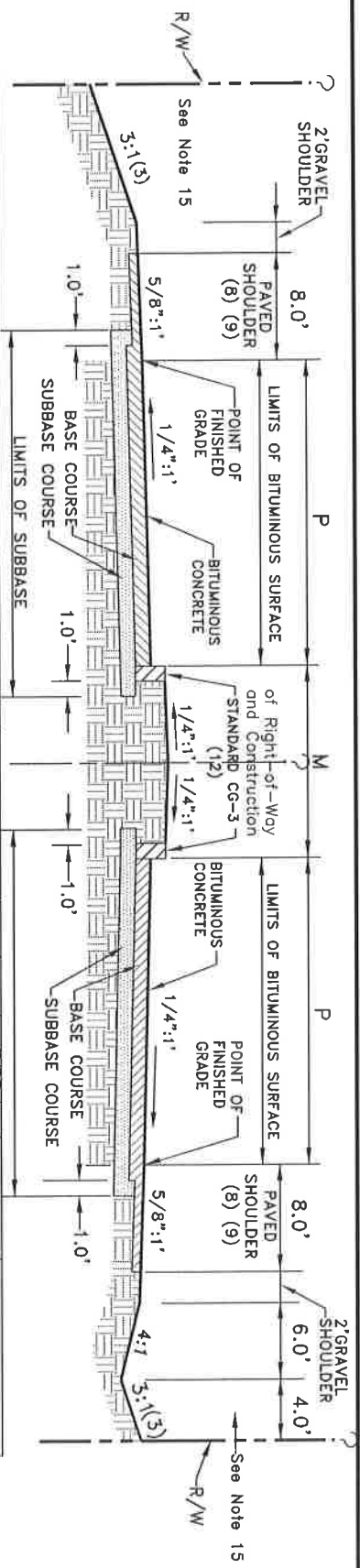

CATEGORY	TRAFFIC VOLUME (VPD)	R.O.W. WIDTH (ft.)	DESIGN SPEED (mph)	MAX GRADE	MIN C.L. RADIUS (ft.)	MIN. SIGHT DISTANCE STOP INTX (ft.)	M	P	TYPE 1 SUBBASE AGG. BASE (21-B)	BASE (BM-25.0A)	SURFACE (SM-9.5A UP TO 10,000 VPD OR 9.5D OVER 10,000 VPD)	
VI (MC-2) (10)	7,001 TO 15,000 W/ RAISED MEDIAN	106	45	7%	716	360	SEE NOTE 16	16	25	8 in	8 in	2 in
VII (MA-2) (11)	15,000 TO 25,000 W/ RAISED MEDIAN	106	50	5%	955	425	SEE NOTE 16	16	25	8 in	9 in	1.5 in

GENERAL NOTES:

- Individual residential lots shall not front on these category streets.
- No parking permitted.
- 2:1 slopes will be allowed when soil type supported by soil report is acceptable and where a special stabilization is provided in accordance with the Erosion Control ordinance.
- Additional right-of-way may be required to accommodate channelization (additional right/left turn lanes) at major intersections.
- Standard landings required at intersections.
- Super-elevation shall be provided for Category VI or VII streets in accordance with the current VDOT Road and Bridge Standards for Rural Roadways.
- Pavement section shown is standard requirement. Refer to Detail 650.01 for alternative pavement sections.
- Paved shoulders shall conform to VDOT requirements of ITM-LD-158 201 and shall be stabilized with six (6) inches of aggregate base material and two (2) inches of SM-12.5A asphalt concrete. These are the minimum required thicknesses and pavement designs should be verified using 5% to 10% traffic counts from the main travel lane.
- Wider shoulders shall be required in accordance with VDOT standards where guardrails are required.
- This street section shall be used when the traffic volume exceeds 7,000 VPD but not greater than 15,000 VPD, or when the roads are designated as major collectors in the Comprehensive Plan.
- This street section shall be used when traffic volume exceeds 15,000 VPD, but not greater than 25,000 VPD, or when the roads are designated as rural minor arterial in the Comprehensive Plan.
- When design speeds are greater than or equal to 45 MPH, the median curb is to be shopped in accordance with VDOT Standard CG-3.
- Median shall conform to VDOT Standards MS-1, MS-1A or MS-2 as appropriate.
- Underdrains shall be provided.
- Right-of-way to accommodate all required components of the typical section including, but not limited to turn lanes, sidewalks, shared use paths, buffer areas, street plantings in accordance with Section 802.46 of this manual, and signs.
- SDL, Sight Distance Left (for a vehicle looking left and making a right or left turn) = 530' (at 45 MPH) and 590' (at 50 MPH). SDR, Sight Distance Right (for a vehicle looking right and making a left turn) = 615' (at 45 MPH) and 680' (at 50 MPH). Otherwise, use latest VDOT or ASSHTO standards, whichever is more stringent.

Detail No.	MC-2	 COUNTY OF PRINCE WILLIAM VIRGINIA	STANDARD TYPICAL SECTION FOR MAJOR COLLECTOR STREETS AND MINOR ARTERIAL STREETS AS DESIGNATED BY THE COMPREHENSIVE PLAN (4 LANE DIVIDED WITHOUT CURB AND GUTTER)
650.10	MA-2		Date 7/15/14

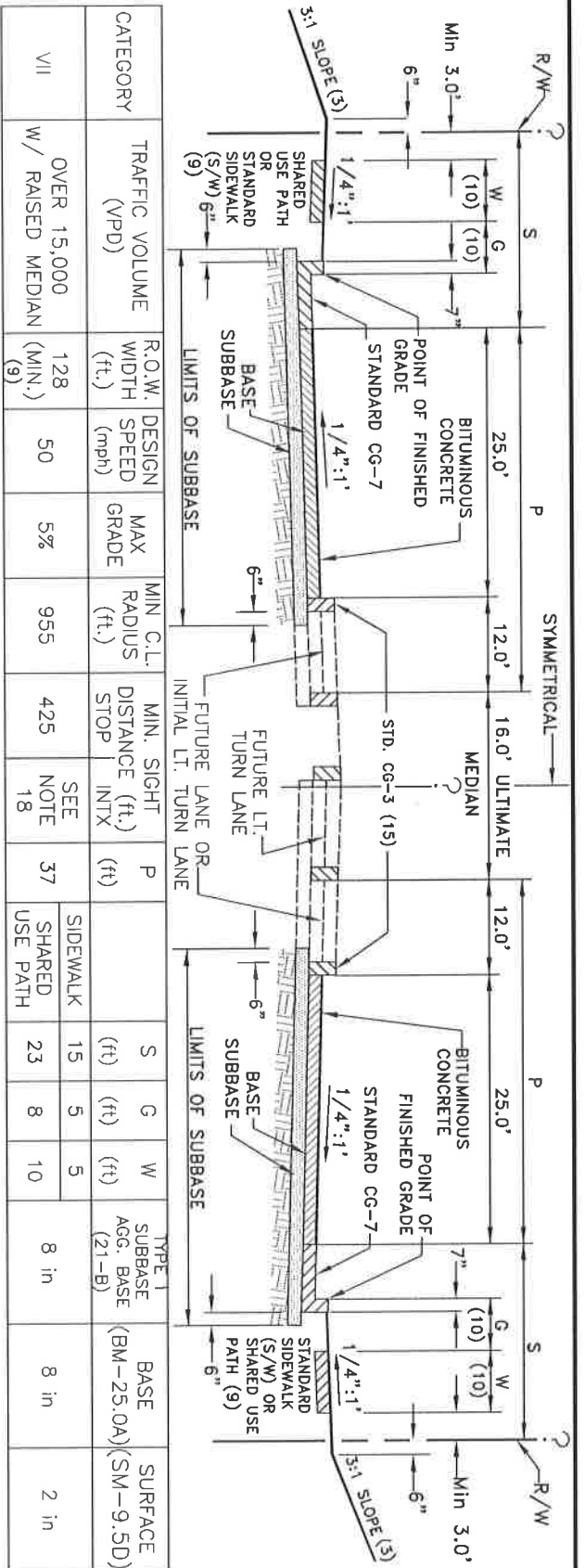

GENERAL NOTES:

1. This street section shall be used when the traffic volume exceeds 15,000 VPD or when the roads are designated minor arterial by the Comprehensive Plan.
2. Slope easements not included in right-of-way.
3. 2:1 slopes will be allowed when soil type supported by soil report is acceptable and when special stabilization is provided in accordance with the Erosion Control ordinance.
4. Stone material shall extend under the curb and gutter a minimum of six (6) inches beyond the back of curb. The aggregate thickness under the curb and gutter shall be that in excess of the depth of the gutter face or a minimum of four (4) inches, whichever is greater.
5. Individual parcels/lots shall not have direct access on this street.
6. Additional right-of-way may be required to accommodate channelization (right/left turn lanes) at major intersections.
7. No parking permitted.
8. Standard landings required at intersections.
9. Sidewalks and/or shared use paths shall be provided in accordance with Section 602.18 and with the County's Comprehensive Plan. Minimum right-of-way dimension shown includes one sidewalk and one shared use path.
10. The width of G and W shall vary depending upon the sidewalk/shared use path and planting requirements. This may require additional right-of-way or easement.
11. Super-elevation shall be provided for Category VII street in accordance with the current VDOT Road and Bridge Standards for Urban Roadways.
12. Design speed shall be 50 MPH or in accordance with VDOT standards, whichever is greater.
13. Pavement section shown is standard requirement. Refer to Detail 650.01 for alternative pavement sections.
14. Over 25,000 VPD will require the construction of the 6 Lane Section.
15. Median shall conform to VDOT standards MS-1, MS-1A or MS-2 as appropriate.
16. Underdrains shall be provided.
17. Right-of-way to accommodate all required components of the typical section including, but not limited to turn lanes, sidewalks, shared use paths, buffer areas, street plantings in accordance with Section 802.46 of this manual, and signs.
18. S.D.L., Sight Distance Left = 625'. S.D.R., Sight Distance Right = 720' (assuming ultimate 6-lane section and 50 mph design speed). Otherwise, use latest VDOT or AASHTO standards, whichever is more stringent. Intersection sight distance should be based on the ultimate plan and computed in accordance with Chapter 9 of the AASHTO Green Book.

CATEGORY	TRAFFIC VOLUME (VPD)	R.O.W. WIDTH (ft.)	DESIGN SPEED (mph)	MAX GRADE	MIN. C.L. RADIUS (ft.)	MIN. SIGHT DISTANCE STOP (ft.)	P	S	G	W	TYPE 1 SUBBASE AGG. BASE (21-B)	BASE (BM-25.0A) (SM-9.5D)	SURFACE (SM-9.5D)	
VII	OVER 15,000 W/ RAISED MEDIAN	128 (9)	50	5%	955	425	SEE NOTE 18	37	15	5	5	8 in	8 in	2 in

Detail No.	650.11	MA-1		COUNTY OF PRINCE WILLIAM VIRGINIA	STANDARD TYPICAL SECTION FOR URBAN MINOR ARTERIAL STREETS AS DESIGNATED BY THE COMPREHENSIVE PLAN (6 LANE DIVIDED WITH CURB AND GUTTER)	Date 7/15/14
------------	--------	------	--	-----------------------------------	---	-----------------

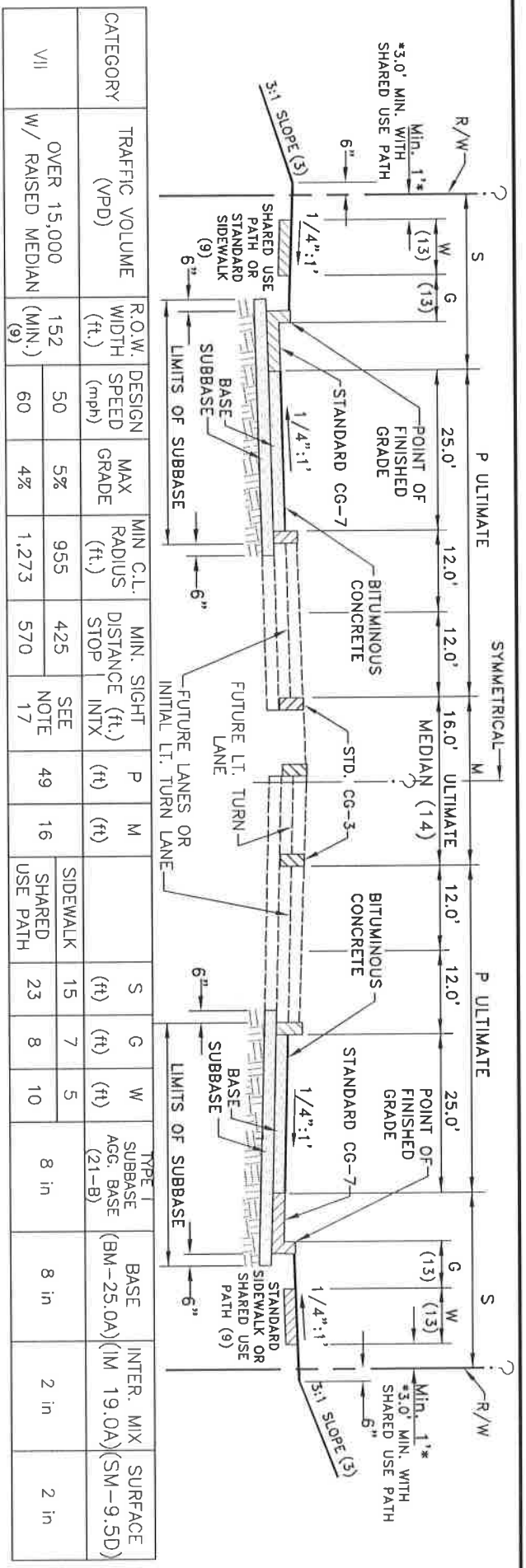

GENERAL NOTES:

- This street shall be used when roads are designated as principal arterial or parkways by the Comprehensive Plan.
- Slope easements not included in right-of-way.
- 2:1 slopes will be allowed when soil report is acceptable and when special stabilization is provided in accordance with the Erosion Control ordinance.
- Stone material shall extend under the curb and gutter a minimum of six (6) inches beyond the back of curb. The aggregate thickness under the curb and gutter shall be that in excess of the depth of the gutter face or a minimum of four (4) inches, whichever is greater.
- Individual parcels/lots shall not have direct access on this street.
- Additional right-of-way may be required to accommodate channelization (right/left turn lanes) at major intersections.
- No parking permitted.
- Standard landings required at intersections.
- Sidewalks and/or shored use paths shall be provided in accordance with Section 602.18 and with the County's Comprehensive Plan. Minimum right-of-way dimension shown includes one sidewalk and one shored use path.
- Superelevation shall be provided for Category VII street in accordance with the current VDOT Road and Bridge Standards for Urban Roadways. Additional right-of-way may be needed to accommodate the superelevation.
- Design speed shall be 60 MPH or in accordance with VDOT standards, whichever is greater.
- Pavement section shown is standard requirement. Refer to Detail 650.01 for alternative pavement sections.
- The width of G and W shall vary depending upon the sidewalk/shored use path and planting requirements. This may require additional right-of-way or easement.
- Median shall conform to VDOT standards MS-1, MS-1A or MS-2 as appropriate.
- Underdrains shall be provided.
- Right-of-way to accommodate all required components of the typical section including, but not limited to turn lanes, sidewalks, shored use paths, buffer areas, street plantings in accordance with Section 802.46 of this manual, and signs.
- Use latest VDOT or ASSHTO standards, whichever is more stringent. Intersection sight distance should be based on the ultimate plan and computed in accordance with Chapter 9 of the AASHTO Green Book.

CATEGORY	TRAFFIC VOLUME (VPD)	R.O.W. WIDTH (ft.)	DESIGN SPEED (mph)	MAX GRADE	MIN C.L. RADIUS (ft.)	MIN. SIGHT DISTANCE (ft.)	P (ft)	M (ft)	S (ft)	G (ft)	W (ft)	TYPE 1 SUBBASE ACG. BASE (21-B)	BASE (BM-25.0A) (IM 19.0A)	INTER. MIX (SM-9.5D)	SURFACE
VII	OVER 15,000	152	50	5%	955	425	49	16	15	7	5	8 in	8 in	2 in	2 in
	W/ RAISED MEDIAN	(9)	60	4%	1,273	570	17	16	23	8	10				

Detail No.	PA-1	 <p style="margin: 0;">COUNTY OF PRINCE WILLIAM VIRGINIA</p>	<p style="margin: 0; text-align: center;">STANDARD TYPICAL SECTION FOR URBAN PRINCIPAL ARTERIAL/PARKWAYS AS DESIGNATED BY THE COMPREHENSIVE PLAN (ULTIMATE 6 LANE DIVIDED WITH CURB AND GUTTER)</p>
650.12			Date 7/15/14

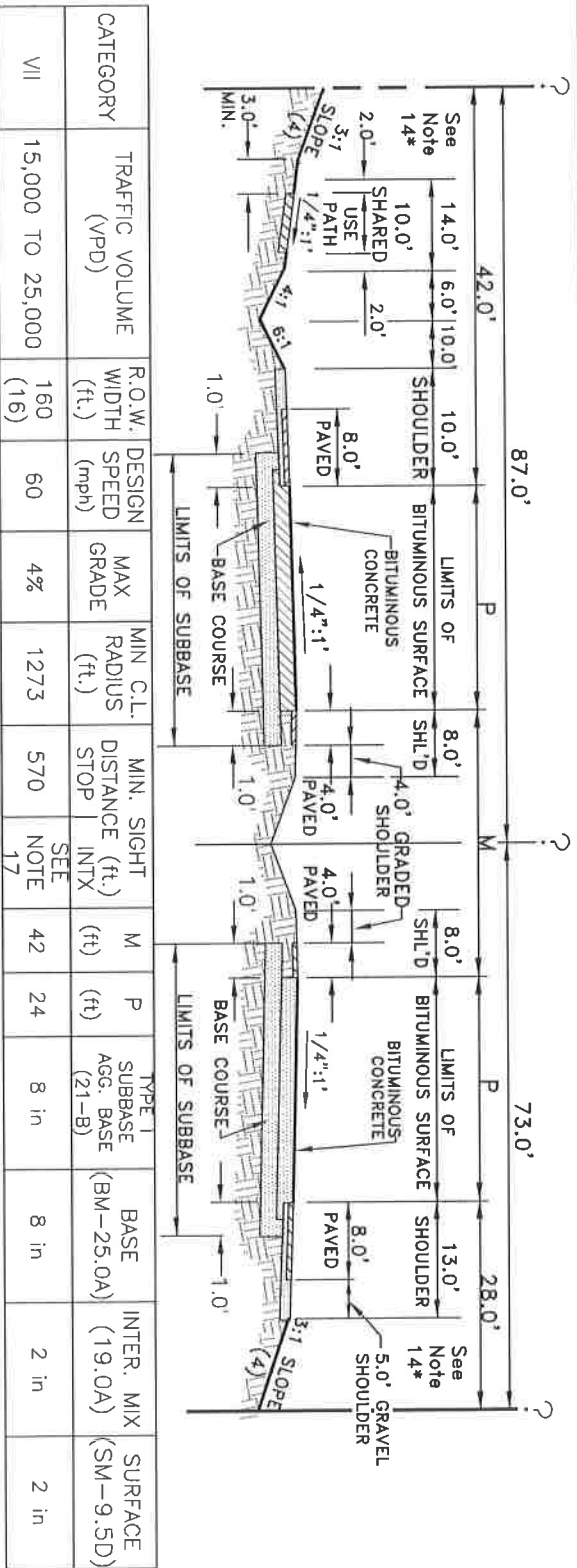

GENERAL NOTES:

- This street shall be used when roads are designated as principal arterial or parkways by the Comprehensive Plan.
- Slope easements not included in right-of-way.
- Use a 1:20 slope for all shoulders.
- 2:1 slopes will be allowed when soil type supported by soil report is acceptable and when special stabilization is provided in accordance with the Erosion Control ordinance.
- Individual parcels/lots shall not have direct access on this street.
- Additional right-of-way may be required to accommodate channelization (right/left turn lanes) at major intersections.
- No parking permitted.
- Standard landings required at intersections.
- Super-elevation shall be provided for Category VII street in accordance with the current VDOT Road and Bridge Standards for Rural Roadways.
- Additional right-of-way may be needed to accommodate the super-elevation.
- Design speed shall be 60 MPH or in accordance with VDOT standards, whichever is greater.
- Pavement section shown is standard requirement. Refer to Detail 650.01 for alternative pavement sections.
- Over 25,000 VPD shall require construction of 6-lane curb and gutter section with raised median (PA-1).
- Underdrains shall be provided. additional right-of-way may be required.
- Right-of-way to accommodate all required components of the typical section including, but not limited to turn lanes, sidewalks, shared use paths, buffer areas, street plantings in accordance with Section 802.46 of this manual and VDOT's guidelines for planting VA's roadways, and signs.
- Pavement shoulder shall conform to VDOT requirements. Shoulders should be stabilized with six (6) inches of aggregate base material and two (2) inches of SM-12.5A asphalt. The minimum required thickness and design should be verified using 5% and 10% traffic counts from the main travel lane.
- Additional right-of-way may be required for adopted intra-county parkways.
- SDL, Sight Distance Left (for a vehicle looking left and making a right or left turn) = 710'. SDR, Sight Distance Right (for a vehicle looking right and making a left turn) = 820'. Otherwise, use latest VDOT or ASSHTO standards, whichever is more stringent. Intersection sight distance should be based on the ultimate plan and computed in accordance with Chapter 9 of the AASHTO Green Book.

Detail No.	PA-2	<p style="text-align: center; margin: 0;">COUNTY OF PRINCE WILLIAM VIRGINIA</p>	<p style="margin: 0;">STANDARD TYPICAL SECTION FOR PRINCIPAL ARTERIAL/PARKWAYS AS DESIGNATED BY THE COMPREHENSIVE PLAN (4 LANE DIVIDED INITIALLY)</p>
650.13	Date 7/15/14		

GENERAL NOTES (CONT'D):

- 16. A separate plan for landscaping and irrigation inside the right-of-way should be submitted to VDOT for review and approval.
- 17. Tree pits and strips will be a minimum of 6' wide and must be located adjacent to the sidewalk or shared use path, behind the back of curbs on both sides of the street. Tree pits should be a minimum of 8' long. See Detail 650.19.
- 18. Street trees shall be placed a minimum of 30' from the face of curb of the intersecting street or entrance and outside the line of sight on all sides of the intersection.
- 19. VDOT will maintain up to the standard sidewalk width within the right-of-way or as approved. A longitudinal joint should separate the VDOT sidewalk from the private sidewalk extension.
- 20. A one foot (1') wide sidewalk maintenance easement is required behind the edge of the sidewalk where the sidewalk extends past the right-of-way line.
- 21. Street/pedestrian lights, gardens, and stair railings should be located behind the right-of-way within private property.
- 22. SDL, Sight Distance Left (for a vehicle looking left and making a right or left turn) = 530'. SDR, Sight Distance Right (for a vehicle looking right and making a left turn) = 615'. Otherwise, use latest VDOT or AASHTO standards, whichever is more stringent.
- 23. Right-of-way to accommodate all required components of the typical section including, but not limited to turn lanes, sidewalks, shared use paths, buffer areas, street plantings in accordance with Section 802.46 of this manual, and signs.

Detail No.	UTB-1		COUNTY OF PRINCE WILLIAM VIRGINIA	STANDARD TYPICAL SECTION FOR THROUGH BOULEVARD IN URBAN CENTERS (SHEET 2 OF 2)	Date 7/15/14
650.14					

GENERAL NOTES:

1. This typical cross section shall be used in urban centers as defined in Section 601.02 of the DCSM or as otherwise approved by the Director of Transportation.
2. Standard landings required at intersections.
3. Stone material shall extend under the curb and gutter a minimum of six inches (6 in.) beyond the back of curb. The stone thickness under the curb and gutter shall be that in excess of the depth of the gutter face or a minimum of four inches (4 in.) whichever is greater.
4. 2:1 slopes will be allowed when soil type supported by soil report is acceptable and where stabilization is provided in accordance with the Erosion Control ordinance.
5. Pavement section shown is standard requirement. Refer to Detail 650.01 for alternative pavement sections.
6. Super-elevation shall be provided in accordance with VDOT Road and Bridge Standards.
7. Underdrains shall be required. A modified UD-4 shall be used on each side of the optional median.
8. Dedicated bicycle lanes must be a minimum of 6' wide.
9. Sidewalks no less than 5' wide must be located on both sides of the Boulevard. A 10' wide shared use path will be allowed on one side instead of the sidewalk with the approval of the Director of Transportation. If connectivity for bicycles is provided through the use of the shared use path, both on-street bicycle lanes may be eliminated with the approval of the Director of Transportation.
10. VDOT will maintain up to the standard sidewalk width within the right-of-way or as approved. A longitudinal joint should separate the VDOT sidewalk from the private sidewalk extension.
11. A one foot (1') wide sidewalk maintenance easement is required behind the edge of sidewalk where the sidewalk extends past the right-of-way line.
12. An optional raised landscape median shall be designed in accordance with VDOT standards as appropriate and must be between 16' and 36' (with a 2' offset) to accommodate a single left-turn lane at intersections.
13. If transit is provided where on-street parking is allowed, the on-street parking lane must clearly terminate in advance of the nearest intersection to provide adequate space for transit pull-offs.
14. Pedestrian lights, gardens, and stair-rolings should be located behind the public right-of-way within private property.
15. A separate plan for landscaping and irrigation inside the right-of-way should be submitted to VDOT for review and approval.
16. Additional right-of-way may be required to accommodate channelization (right/left turn lanes) and/or signalization at intersections.
17. Right-of-way to accommodate all required components of the typical section including, but not limited to turn lanes, sidewalks, shared use paths, buffer areas, street plantings in accordance with Section 802.46 of this manual, and signs.

Detail No.	UB-1	 COUNTY OF PRINCE WILLIAM VIRGINIA	STANDARD TYPICAL SECTION FOR BOULEVARD IN URBAN CENTERS (SHEET 2 OF 3)	Date 7/15/14
650.15				

OPTION WITHOUT CURB EXTENSION

OPTION WITH CURB EXTENSION (5)

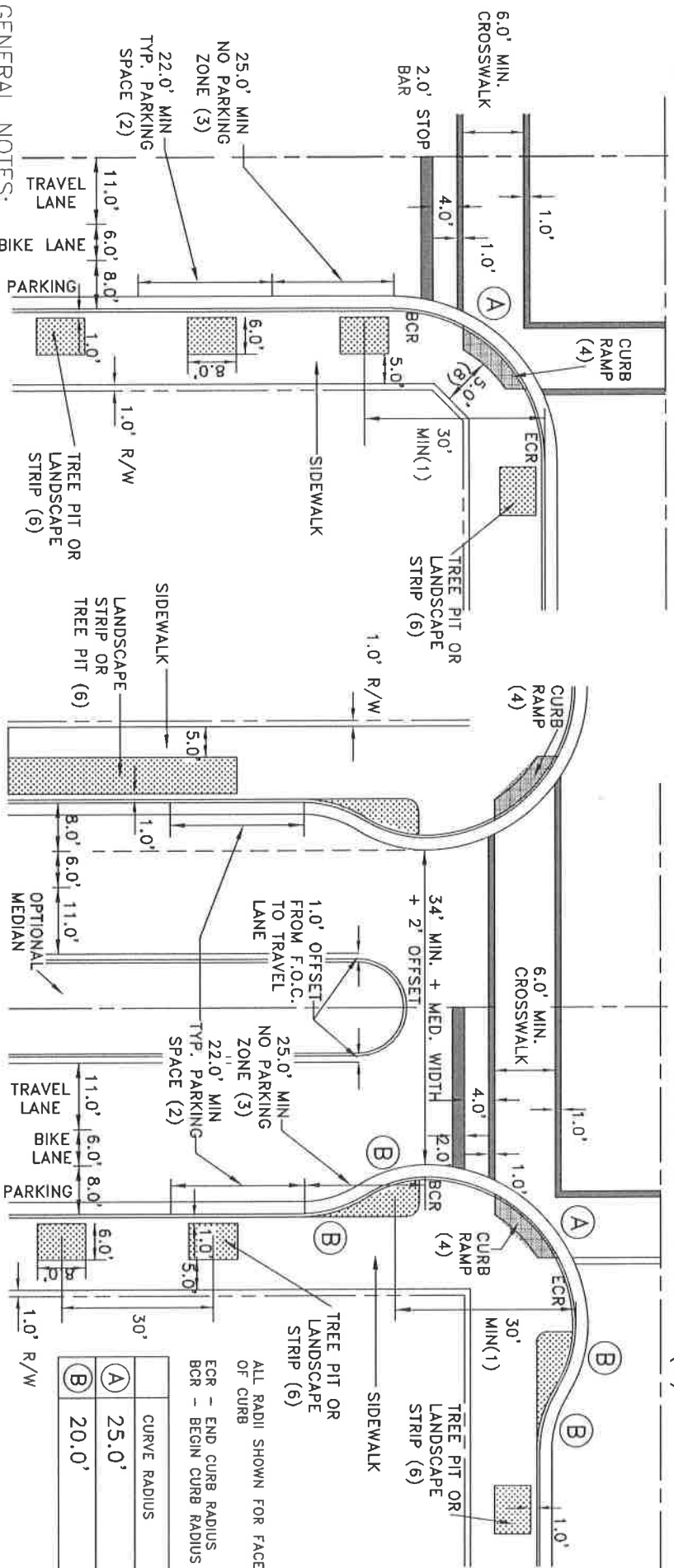

GENERAL NOTES:

1. Street trees shall be placed a minimum of 30' from the face of curb of the intersecting street or entrance and outside the line of sight on all sides of the intersection.
2. Parallel Parking spaces are 22' long and 8' wide.
3. "No Parking Zone" is measured from the end or beginning of curb radius for a minimum distance of 25' or longer to accommodate intersection sight distance, transit, and turning movements.
4. Refer to current VDOT CG-12 standards for design of curb ramps and other available curb ramp options.
5. An optional curb extension to the edge of parking at intersection corners is permitted. The turning characteristics of a 45' long bus must be adequately demonstrated.
6. Street trees must be planted centered within a tree pit or in a landscape strip. Tree pits shall be located between sidewalk and the back of curb and shall be no less than 6' wide and 8' long. See Detail 650.19.
7. A 10' wide shared use path will be allowed on one side instead of the sidewalk with the approval of the Director of Transportation.
8. Sidewalk width at corners must be maintained by truncating property boundary if necessary.
9. A separate plan for landscaping and irrigation inside the right-of-way should be submitted to VDOT for review and approval.

Detail No.	UB-1	COUNTY OF PRINCE WILLIAM VIRGINIA	LAYOUT DESIGN FOR BOULEVARD IN URBAN CENTERS (SHEET 3 OF 3)	Date 7/15/14
650.15				

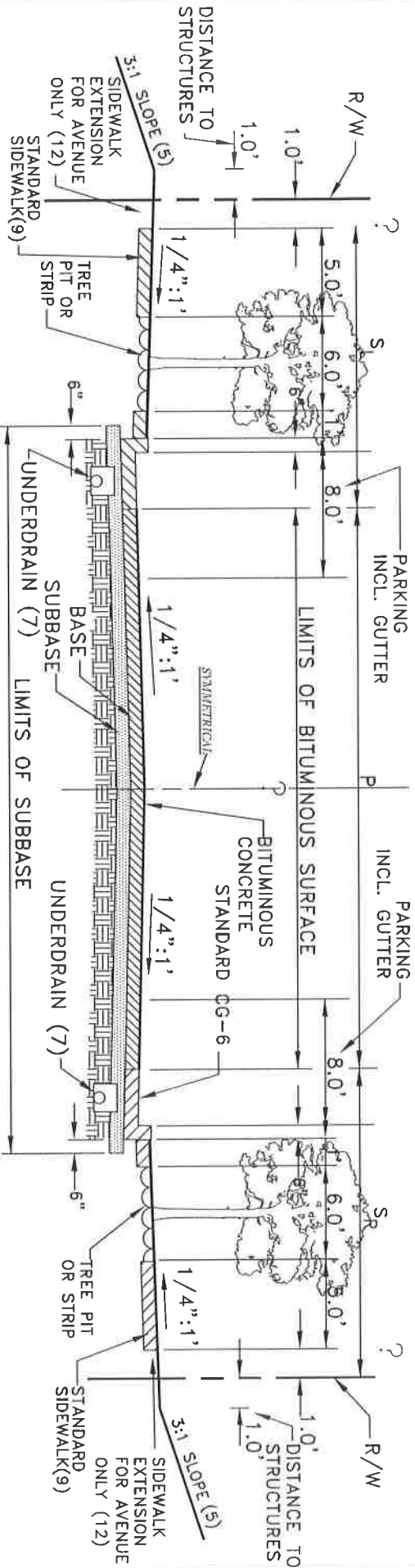

CATEGORY	TRAFFIC VOLUME (VPD)	R.O.W. WIDTH (ft.)	DESIGN SPEED (mph)	MAX GRADE	MIN C.L. RADIUS (ft.)	MIN. SIGHT DISTANCE STOP (ft.)	S _L (ft)	P (ft)	S _R (ft)	TYPE 1 SUBBASE AGG. BASE (21-B) (5)	BASE (BM-25.0A) (SM-9.5A) (5)	SURFACE (SM-9.5A) (5)
STREET	0 TO 2,000	65	25	10%	200	155	280	15.5	34	15.5	8 in.	6 in.
AVENUE	2,001 TO 4,000	71	25	10%	200	155	280	15.5	40	15.5	8 in.	6 in.

OPTIONAL MEDIAN (FOR AVENUE):

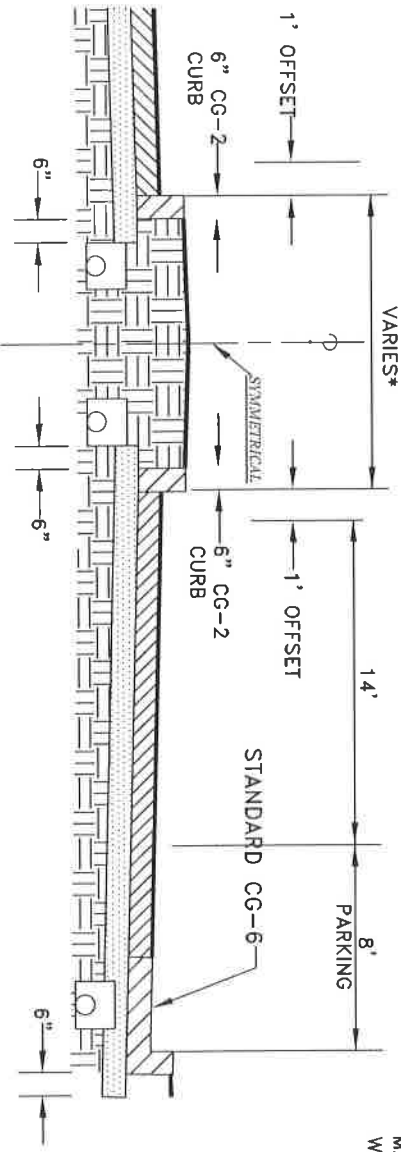

* - RANGES FROM 16'-36' MAY BE REDUCED TO 10' MIN. WITH A WAIVER (SEE #14)

Detail No.

650.16

UAS-1



COUNTY OF PRINCE WILLIAM VIRGINIA

STANDARD TYPICAL SECTION FOR AVENUE AND STREET IN URBAN CENTERS (SHEET 1 OF 4)

Date

7/4/14

GENERAL NOTES:

1. This typical cross section shall be used in urban centers as defined in Section 601.02 of the DCSM or as otherwise approved by the Director of Transportation.
2. Standard landings required at intersections.
3. Stone material shall extend under the curb and gutter a minimum of six inches (6 in.) beyond the back of curb. The stone thickness under the curb and gutter shall be that in excess of the depth of the gutter face or a minimum of four inches (4 in.) whichever is greater.
4. No super-elevation is required.
5. 2:1 slopes will be allowed when soil type supported by soil report is acceptable and where stabilization is provided in accordance with the Erosion Control ordinance.
6. Pavement section is standard requirement. Refer to Detail 650.01 for alternative pavement sections.
7. Underdrains shall be required where traffic volumes exceed 1,000 vpd.
8. If transit is provided where on-street parking is allowed, the on-street parking lane must clearly terminate in advance of the nearest intersection to provide adequate space for transit pull-offs.
9. Sidewalks no less than 5' wide shall be provided on both sides of the Avenue or Street. A 10' wide shared use path will be allowed on one side instead of the sidewalk with the approval of the Director of Transportation.
10. VDOT will maintain up to the standard sidewalk width within the right-of-way or as approved. A longitudinal joint should separate the VDOT sidewalk from the private sidewalk extension.
11. A one foot (1') wide sidewalk maintenance easement is required behind the edge of sidewalk where the sidewalk extends past the right-of-way line.
12. For Avenue, sidewalk materials must extend to property line.
13. Street/pedestrian lights, gardens, and stair railings should be located behind the public right-of-way within private property.
14. Right-of-way to accommodate all required components of the typical section including, but not limited to turn lanes, sidewalks, shared use paths, buffer areas, street plantings in accordance with Section 802.45 of this manual, and signs.

NOTES THAT APPLY TO AVENUE ONLY

17. An optional raised landscape median shall be between 16' and 36' wide (with a 2' offset) and will accommodate single left-turn lanes at intersections. Subject to waiver approval, the optional raised landscape median may be reduced to no less than 10' wide (with a 2' offset) unless left turn lanes are required.
18. Two (2) 14' wide travel lanes, one (1) in each direction are REQUIRED. These shared-use facilities can accommodate transit, trucks, personal vehicles, and on-road bicycle traffic. Lanes can be reduced to 11' wide at the discretion of the Director of Transportation if it can be shown that bicycle lanes can be provided on a parallel facility.

Detail No.	UAS-1	 COUNTY OF PRINCE WILLIAM VIRGINIA	STANDARD TYPICAL SECTION FOR AVENUE AND STREET IN URBAN CENTERS (SHEET 2 OF 4)	Date 7/15/14
650.16				

OPTION WITHOUT CURB EXTENSION

OPTION WITH CURB EXTENSION (5)

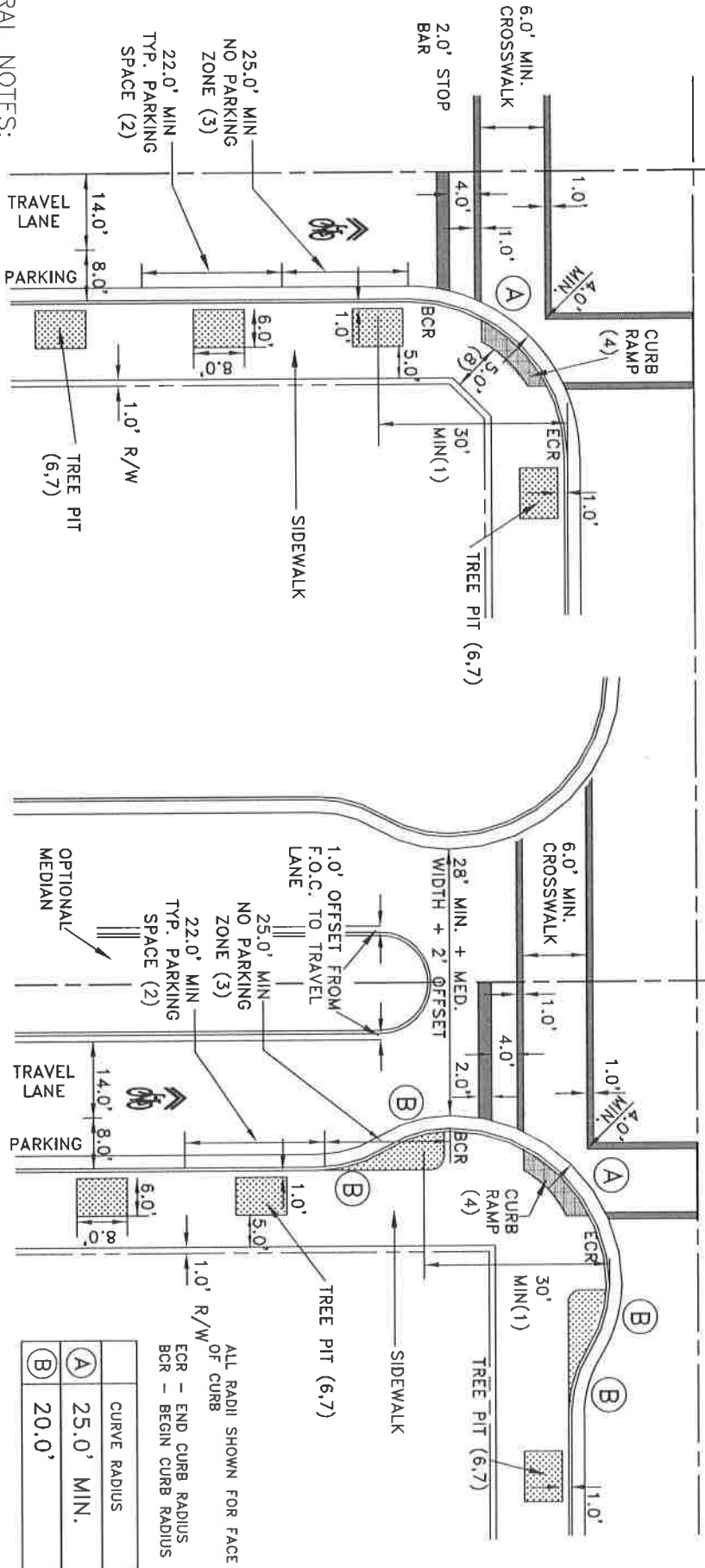

ALL RADII SHOWN FOR FACE OF CURB

ECR - END CURB RADIUS	
BCR - BEGIN CURB RADIUS	
CURVE RADIUS	(A) 25.0' MIN.
	(B) 20.0'

GENERAL NOTES:

1. Street trees shall be placed a minimum of 30' from the face of curb of the intersecting street or entrance and outside the line of sight on all sides of the intersection.
2. Parallel parking spaces are 22' long and 8' wide.
3. "No Parking Zone" is measured from the end or beginning of curb radius for a minimum distance of 25' or longer to accommodate intersection sight distance, transit, and turning movements.
4. Refer to current VDOT CG-12 standards for design of curb ramps and other available curb ramp options.
5. An optional curb extension to the edge of parking at intersection corners is permitted. The turning characteristics of a 45' long bus must be adequately demonstrated.
6. Street trees must be planted centered within a tree pit. See Detail 650.19.
7. Tree pits shall be located between sidewalk and the back of curb and shall be no less than 6' wide and 8' long.
8. Sidewalk width at corners must be maintained by truncating property boundary if necessary.
9. Extra right-of-way may be needed at signalized intersections.
10. A separate plan for landscaping and irrigation inside the right-of-way should be submitted to VDOT for review and approval.
11. Shared bicycle lane markings should be placed in accordance with the latest version of the Manual of Uniform Traffic Control Devices (MUTCD).

Detail No.	 <p>COUNTY OF PRINCE WILLIAM VIRGINIA</p>	<p>LAYOUT DESIGN FOR AVENUE IN URBAN CENTERS (SHEET 3 OF 4)</p>	Date
650.16			7/15/14

OPTION WITHOUT CURB EXTENSION

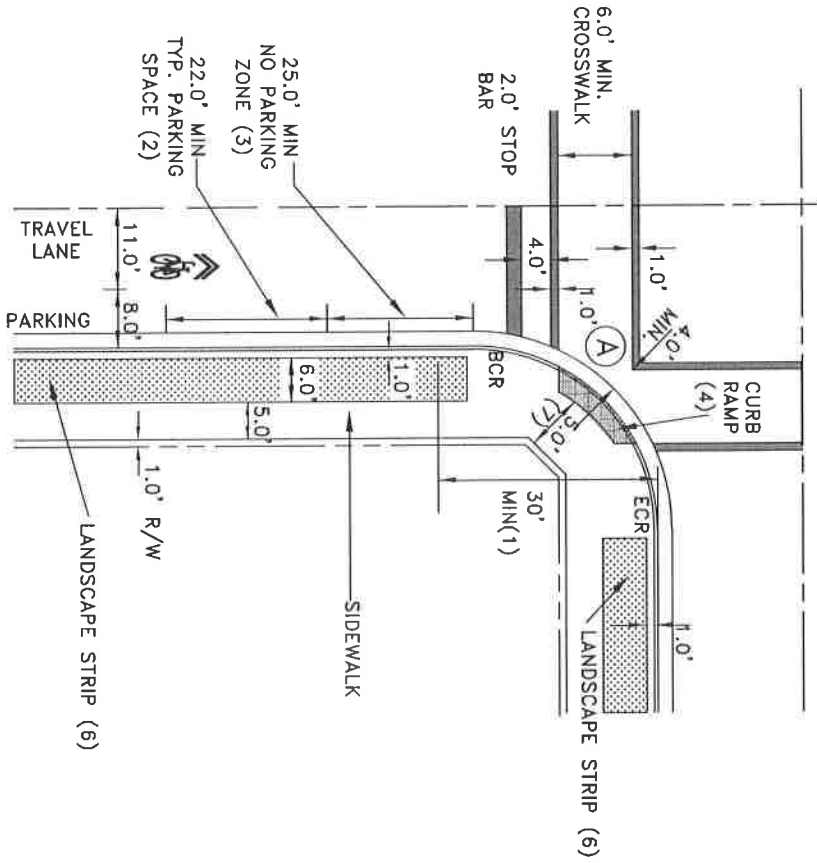

OPTION WITH CURB EXTENSION (5)

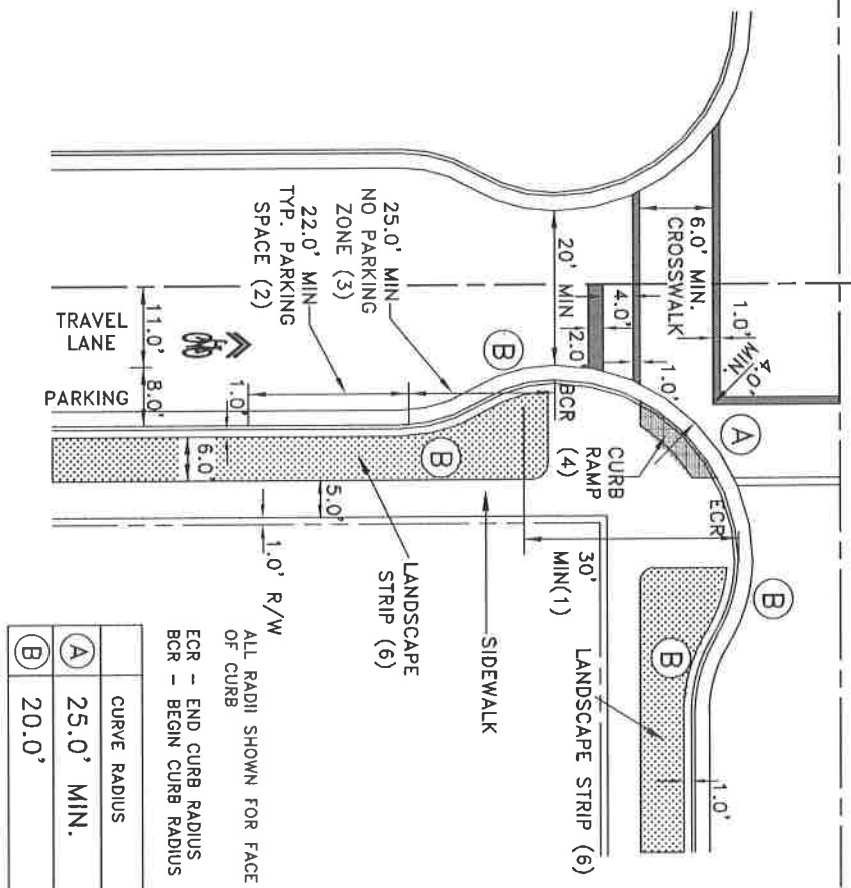

GENERAL NOTES:

1. Street trees shall be placed a minimum of 30' from the face of curb of the intersecting street or entrance and outside the line of sight on all sides of the intersection.
2. Parallel parking spaces are 22' long and 8' wide.
3. "No Parking Zone" is measured from the end or beginning of curb return radius for a minimum distance of 25' or longer to accommodate intersection sight distance, transit, and turning movements. Refer to current VDOT CG-12 standards for design of curb ramps and other available curb ramp options.
4. An optional curb extension to the edge of parking at intersection corners is permitted.
5. Street Trees must be planted in landscape strips no less than 6' wide that are adjacent to the sidewalk and behind the back of curb.
6. Sidewalk width at corners must be maintained by truncating property boundary if necessary.
7. Extra right-of-way may be needed at signalized intersection.
8. A separate plan for landscaping and irrigation inside the right-of-way should be submitted to VDOT for review and approval.
9. Shared bicycle lane markings should be placed in accordance with the latest version of the Manual of Uniform Traffic Control Devices (MUTCD).

Detail No.	COUNTY OF PRINCE WILLIAM VIRGINIA		LAYOUT DESIGN FOR STREET IN URBAN CENTERS (SHEET 4 OF 4)	Date 7/15/14
650.16	UAS-1			

ACCESS EASEMENT

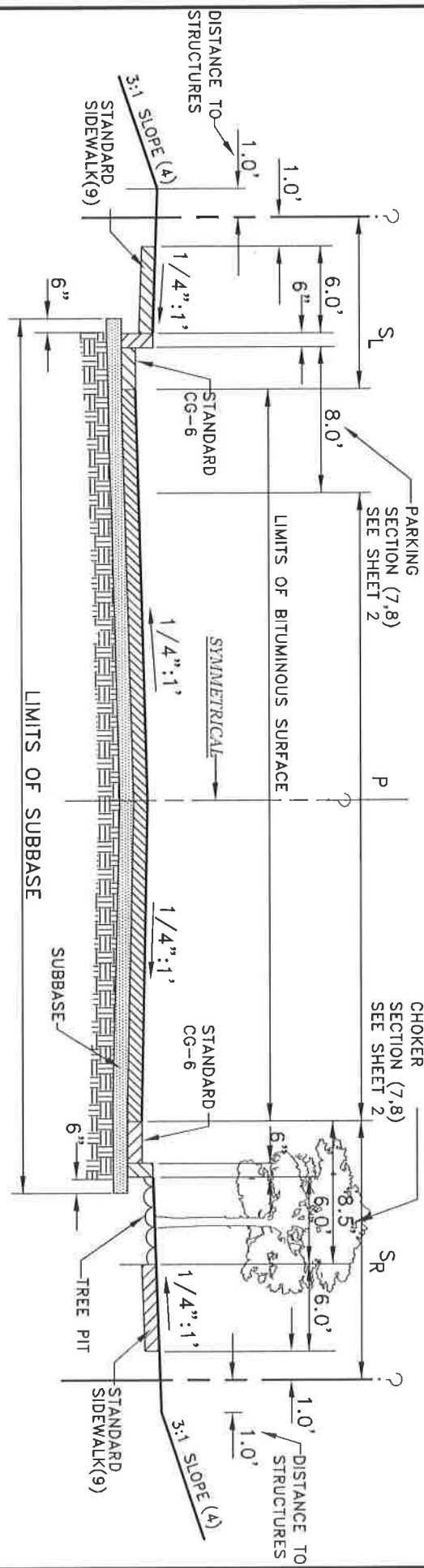

CATEGORY	TRAFFIC VOLUME (VPD)	ACCESS EASEMENT WIDTH (ft.)	DESIGN SPEED (mph)	MAX GRADE	MIN C.L. RADIUS (ft.)	MIN. SIGHT DISTANCE STOP	SIGHT INTX	S _L (ft)	P (ft)	S _R (ft)	TYPE 1 SUBBASE AGG. BASE (21-A) (5)	BASE (BM-25.0A) (5)	SURFACE (SM-9.5A) (5)
I	0 TO 250	51	20	10%	120	125	225	9.5 MIN.	20 MIN.	9.5 MIN.	6 in.	(5)	2 in.
II	251 TO 400	51	20	10%	120	125	225	9.5 MIN.	20 MIN.	9.5 MIN.	8 in.	(5)	2 in.

GENERAL NOTES:

- This typical cross section shall be used in urban centers as defined in Section 601.02 of the DCSM or as otherwise approved by the Director of Transportation.
- Standard landings required at intersections.
- Stone material shall extend under the curb and gutter a minimum of six inches (6 in.) beyond the back of curb. The stone thickness under the curb and gutter shall be that in excess of the depth of the gutter face or a minimum of four inches (4 in.) whichever is greater.
- 2:1 slopes will be allowed when soil type supported by soil report is acceptable and where stabilization is provided in accordance with the Erosion Control ordinance.
- Pavement section shown is standard requirement. Refer to Detail 650.01 for alternative pavement sections.
- No super-elevation is required.
- Chokers are 6' wide and 30' long at the widest point and spaced a minimum of two parking spaces apart and a maximum of four parking spaces apart. Chokers shall be placed within the 8' wide on street parking lanes on both sides of the street.
- When choker is provided, it shall be provided on both sides of the street. Street sections shall be symmetrical.
- Sidewalks no less than 6' wide shall be provided on both sides of the street.
- Utilities should be located within the travel lane so that manholes and valve covers are not within the typical wheel path area.

Detail No.	650.17	UPS-1		COUNTY OF PRINCE WILLIAM VIRGINIA	STANDARD TYPICAL SECTION FOR PRIVATE RESIDENTIAL SIDE STREET IN URBAN CENTERS (SHEET 1 OF 2)	Date 7/15/14
------------	--------	-------	--	-----------------------------------	--	-----------------

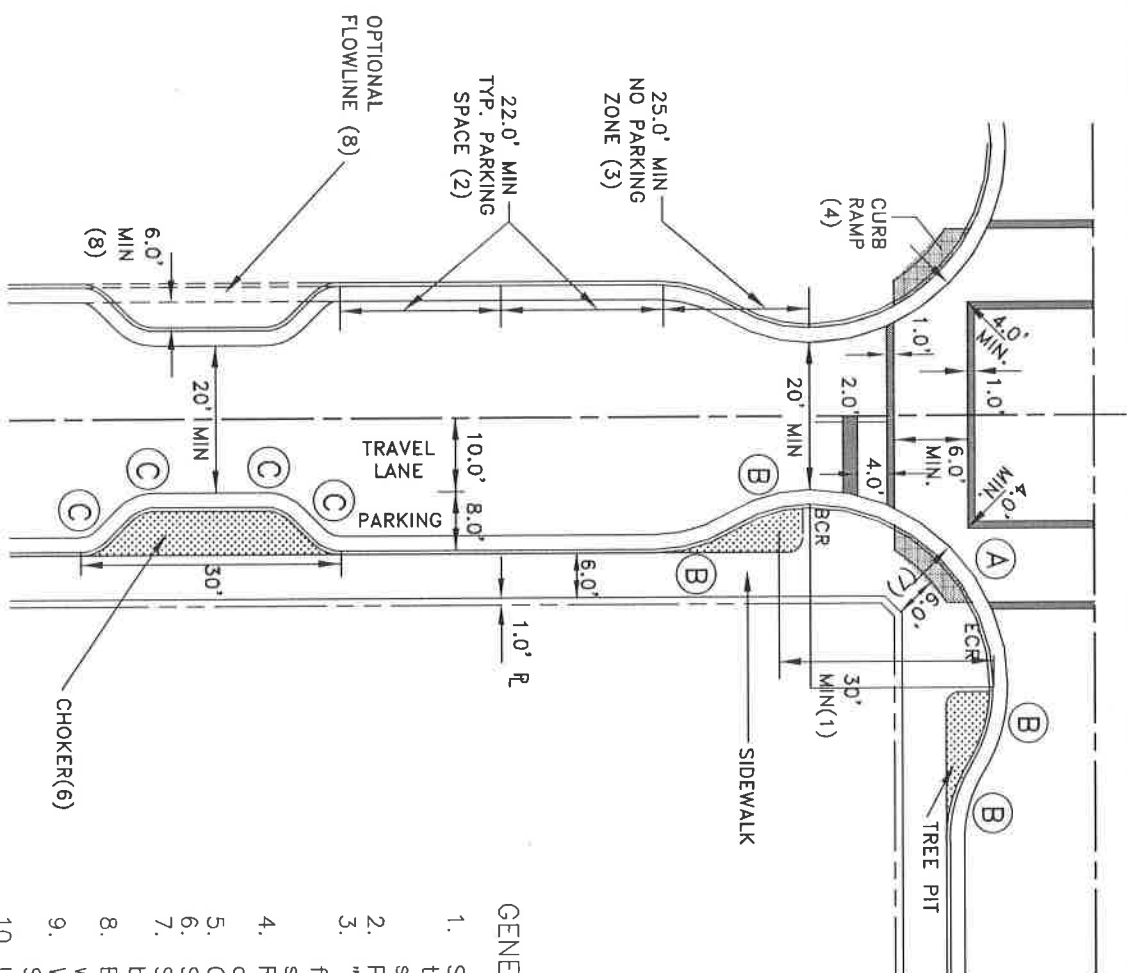

ALL RADII SHOWN FOR FACE OF CURB
 ECR - END CURB RADIUS
 BCR - BEGIN CURB RADIUS

(A)	CURVE RADIUS
(B)	25.0' MIN.
(C)	20.0'
(C)	5.0'

GENERAL NOTES:

1. Street trees shall be placed a minimum of 30' from the face of curb of the intersecting street or entrance and outside the sight distance on all sides of the intersection.
2. Parallel parking spaces are 22' long and 8' wide.
3. "No Parking Zone" is measured from the end or beginning of curb radius for a minimum distance of 25' or longer to accommodate intersection sight distance, transit, and turning movements.
4. Refer to current VDOT CG-12 standards for design of curb ramps and other available curb ramp options.
5. Curb must be extended to edge of parking at intersection corners.
6. Street trees must be placed in each choker.
7. Sidewalk width at corners must be maintained by truncating property boundary if necessary.
8. Extra access easement width may be needed to maintain the 6' minimum width for tree pits in chokers with the alternative flowline option.
9. When choker is provided, it shall be provided on both sides of the street. Street Sections shall be symmetrical.
10. Low Impact Design (LID) practices may be considered in choker areas.

Detail No.
 650.17

UPS-1



COUNTY OF
 PRINCE WILLIAM
 VIRGINIA

PRIVATE SIDE STREET CURB AND
 CHOKER LAYOUT DESIGN IN URBAN
 CENTERS
 (SHEET 2 OF 2)

Date
 7/15/14

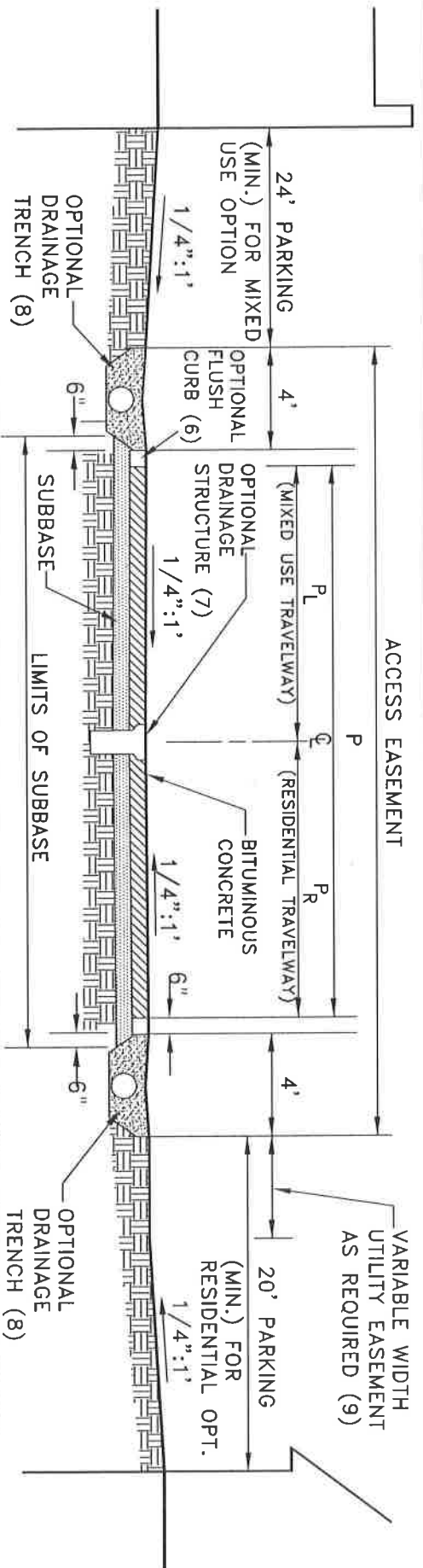

CATEGORY	TRAFFIC VOLUME (VPD)	ACCESS EASEMENT WIDTH (ft.)	DESIGN SPEED (mph)	MAX GRADE	MIN. C.L. RADIUS (ft.)	MIN. SIGHT DISTANCE STOP INTX (ft.)	P _L (ft.)	P (ft.)	P _R (ft.)	TYPE 1 SUBBASE AGG. BASE (3)	BASE (BM-25.0A) (3)	SURFACE (SM-9.5A) (3)
I	UP TO 250	20 MIN.	5-10	10%	120	125	10	20	10	6 in.		2 in.
II	251 TO 400	20 MIN.	5-10	10%	120	125	10	20	10	8 in.		2 in.

GENERAL NOTES:

1. This typical cross section shall be used as a 5-10 mph vehicular driveway located to the rear of properties, providing access to parking, services areas, rear uses such as secondary units, as well as an easement for utilities in urban centers as defined by Section 601.02 of the DCSM or as otherwise approved by the Director of Transportation.
2. Standard landings required at intersections.
3. Pavement section is standard requirement. Refer to Detail 650.01 for alternative pavement sections. Alternative materials such as pervious pavement, cobblestone, etc. may be allowed subject to approval by the Director of Transportation.
4. Private loading and parking access, at least 20' deep, must be located on both sides of the alleyway. (20' for residential uses, 24' for mixed uses)
5. Building edges must meet the easement where vehicular access is not necessary.
6. Curbs must be flush with street surface.
7. Drainage may flow to center inlet. Alley cross slopes may be modified to eliminate center inlet provided that the drainage design shall insure positive drainage.
8. An optional 4' wide trench with grass surface can be located on one or both sides of the alleyway. Trench would require driveway crossovers, surface water flow to be revised, and an addition of 4' or 8' to the access easement.
9. An optional alley easement for dry utilities (i.e. cable, gas, telephone, and electric) could be located on one side of the alley as an alternative to utility placement under the alley. Variable width utility easement shall be provided only as required.
10. Alley entrances shall conform to VDOT CG-11 standards and VDOT Road Design Manual Appendix B(1), Section B(1)-6.
11. Utilities should be located within the travel lane so that manholes and valve covers are not within the typical wheel path area.

Detail No.	650.18	UA-1		COUNTY OF PRINCE WILLIAM VIRGINIA	STANDARD TYPICAL SECTION FOR PRIVATE ALLEY IN URBAN CENTERS	Date 7/15/14
------------	--------	------	--	-----------------------------------	---	-----------------

VERTICAL RISER FOR MANUAL IRRIGATION. PIPE TO BE LOCATED ON SIDE OF ROOT BALL 90° FROM CURB ALIGNED WITH CONTINUOUS SOIL PANEL.

OPTIONAL GROUND COVER, SEASONAL PLANTINGS, OR GRATE

MULCH (3"-4" DOUBLE SHREDDED HARDWOOD MULCH)

ELECTRICAL SERVICE CONDUIT

SIDEWALK

NON-BIODEGRADABLE FILTER FABRIC

ROOT BALL

NON-BIODEGRADABLE FILTER FABRIC

AGGREGATE

DRAINAGE PIPE, AS REQUIRED

NON-BIODEGRADABLE FILTER FABRIC

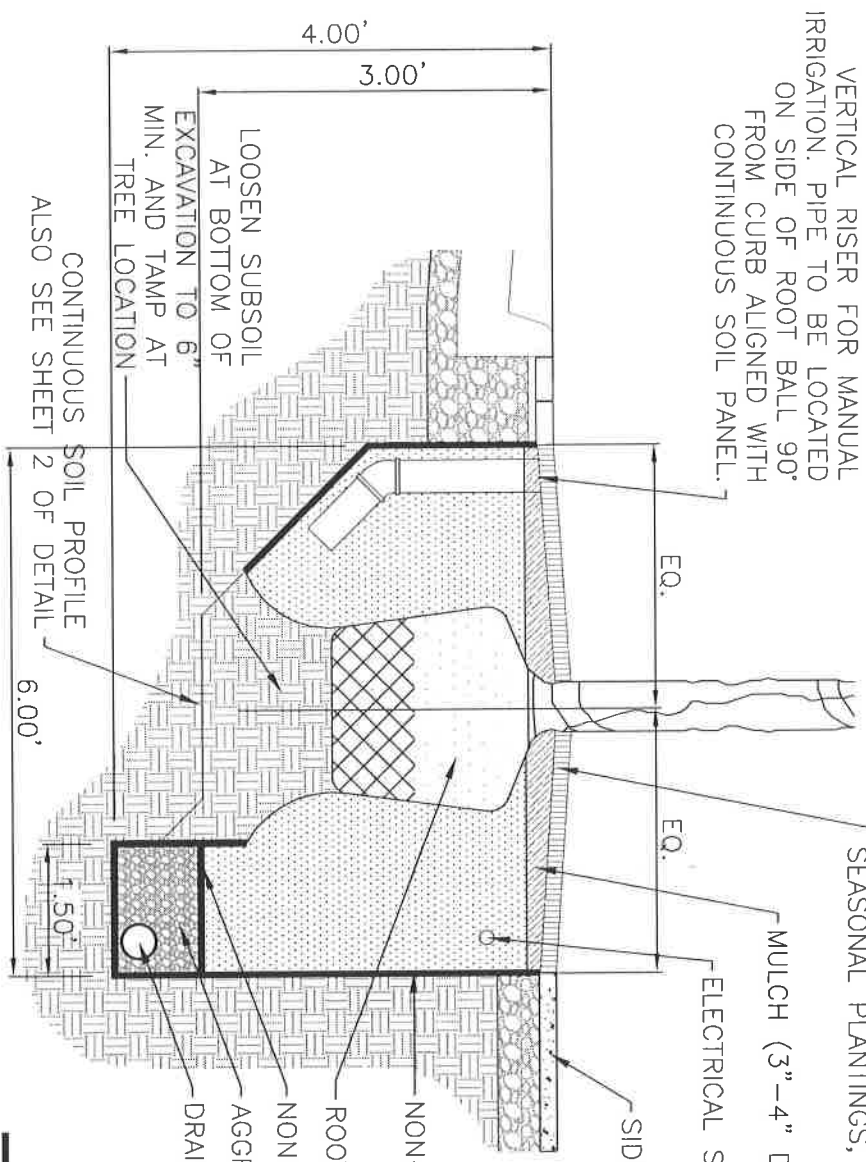

GENERAL NOTES

1. At planting prune only crossing limbs, co-dominant leaders, broken or dead branches, and any branches that pose a hazard to pedestrians.
2. Water thoroughly twice within the first 48 hours after planting.
3. Remove burlap and basket from top 1/3 of root ball and remove from site.
4. Sidewalk shall be constructed in accordance with the approved construction plans.
5. Tree stabilization stakes or guys are to be installed as per manufacturers recommendations.

Detail No.	UST-1	COUNTY OF PRINCE WILLIAM VIRGINIA	STANDARD STREET TREE PLANTING DETAIL FOR URBAN CENTERS SHEET 1 OF 5	Date 7/15/14
650.19				

SUPPORTED SIDEWALK (SEE NOTES ON SHEET 5)

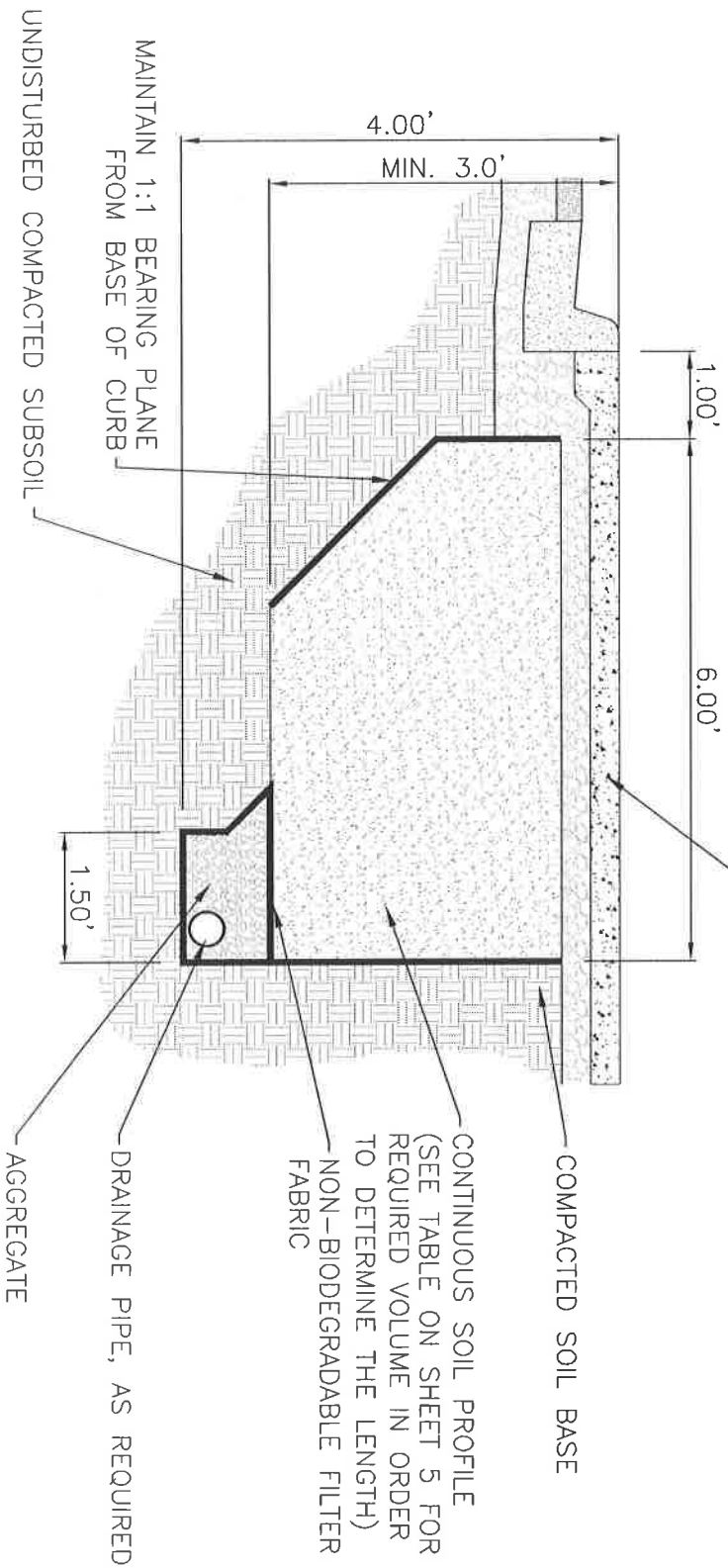

NON-BIODEGRADABLE FILTER FABRIC

Detail No.

650.19

UST-1



COUNTY OF PRINCE WILLIAM VIRGINIA

STANDARD STREET TREE PLANTING DETAIL FOR URBAN CENTERS SHEET 2 OF 5

Date 7/15/14

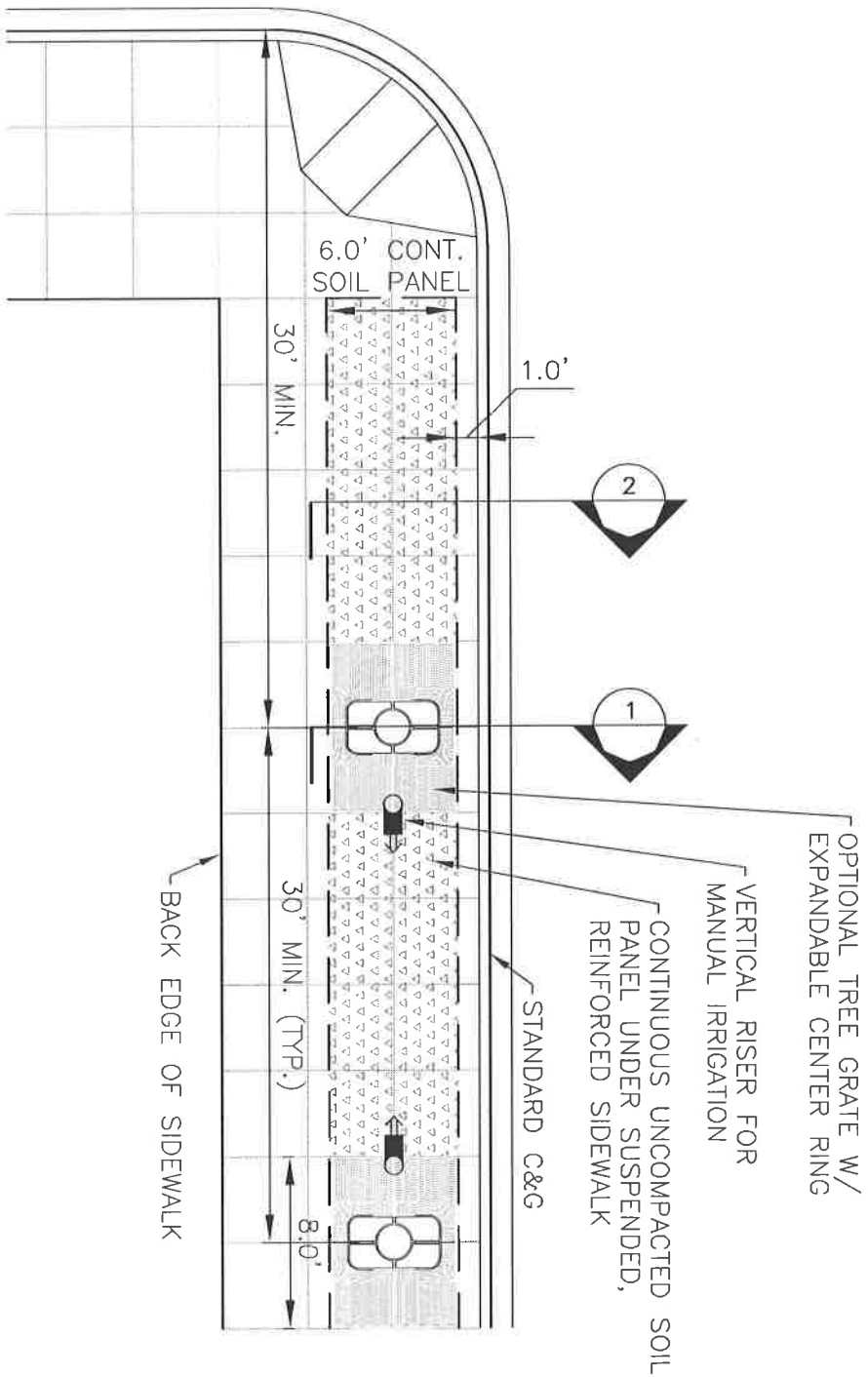

Detail No.

650.19

UST-1



COUNTY OF
PRINCE WILLIAM
VIRGINIA

STANDARD STREET TREE PLANTING DETAIL FOR URBAN
CENTERS
SHEET 3 OF 5

Date
7/15/14

ROOT PATHS ONLY TO BE INSTALLED
IN INSTANCES WHERE SIDEWALK
ABUTS OPEN SPACE.

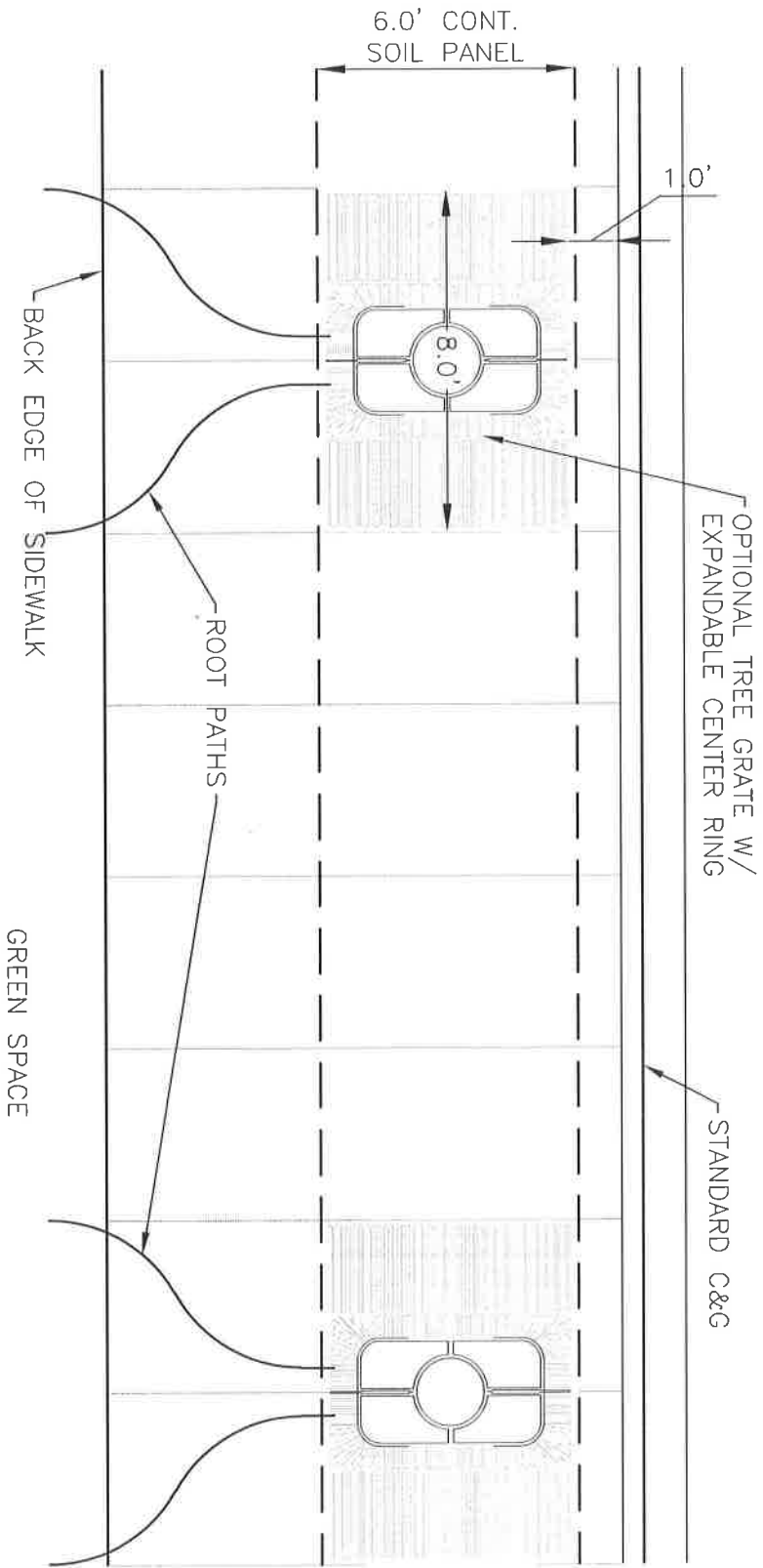

Detail No.

650.19

UST-1



COUNTY OF
PRINCE WILLIAM
VIRGINIA

STANDARD STREET TREE PLANTING DETAIL FOR URBAN
CENTERS
SHEET 4 OF 5

Date
7/15/14

Street Type	Street Tree Size*
Through Boulevard	Large
Boulevard Avenue	Large
Street	Medium
Private Residential Side Street	Medium
Private Side Street	Small
Private Alley	N/A

*See DCSM Section 800 Table 1-2-1.

NOTE: Variation from these tables may be permitted subject to approval by the Prince William County Department of Transportation and Department of Public Works.

Tree Size	Minimum Volume**
Large Street Tree	970 cf
Medium Street Tree	750 cf
Small Street Tree	500 cf

**Minimum Volume Based on Table 8-8 of DCSM.

GENERAL NOTES

1. When tree pits and/or landscape strips are used for urban road sections, a continuous soil profile shall be provided for each street tree based on the required soil volume noted above.
2. Sidewalk over the continuous soil profile must be structurally supported by means that will allow the tree to root within the soil profile. Options for structural support include but are not limited to structural soil, silva cells, and cantilevered sidewalks. The method of support must be approved by the Prince William County Department of Transportation and the the Department of Public Works prior to construction.
3. The method of support for the sidewalk must provide adequate protection to the tree root zone from compaction that may occur above the tree root zone.
4. Within the VDOT ROW the sidewalk will be maintained by VDOT. However, VDOT nor Prince William County maintain the street trees located within the ROW. Maintenance must be provided by others as a condition of plan approval.
5. Trees spaced 30' apart may share volume in one continuous soil profile.
6. Storm sewer structures (inlets, manholes, etc.) should not be placed within tree pits. The top of storm sewer pipes shall be under the continuous soil profile.

Detail No.	UST-1		COUNTY OF PRINCE WILLIAM VIRGINIA	STANDARD STREET TREE PLANTING DETAIL FOR URBAN CENTERS SHEET 5 OF 5	Date
650.19					7/15/14

	CURVE RADIUS
(A)	35.0' MINIMUM
(B)	30.0'

- NOTE:
- STREET DRAINAGE FLOW SHALL FOLLOW THE CURB AND GUTTER.
 - VDOT IIM-LD-55 TO COMPLY WITH ADA AND CODE OF VIRGINIA.

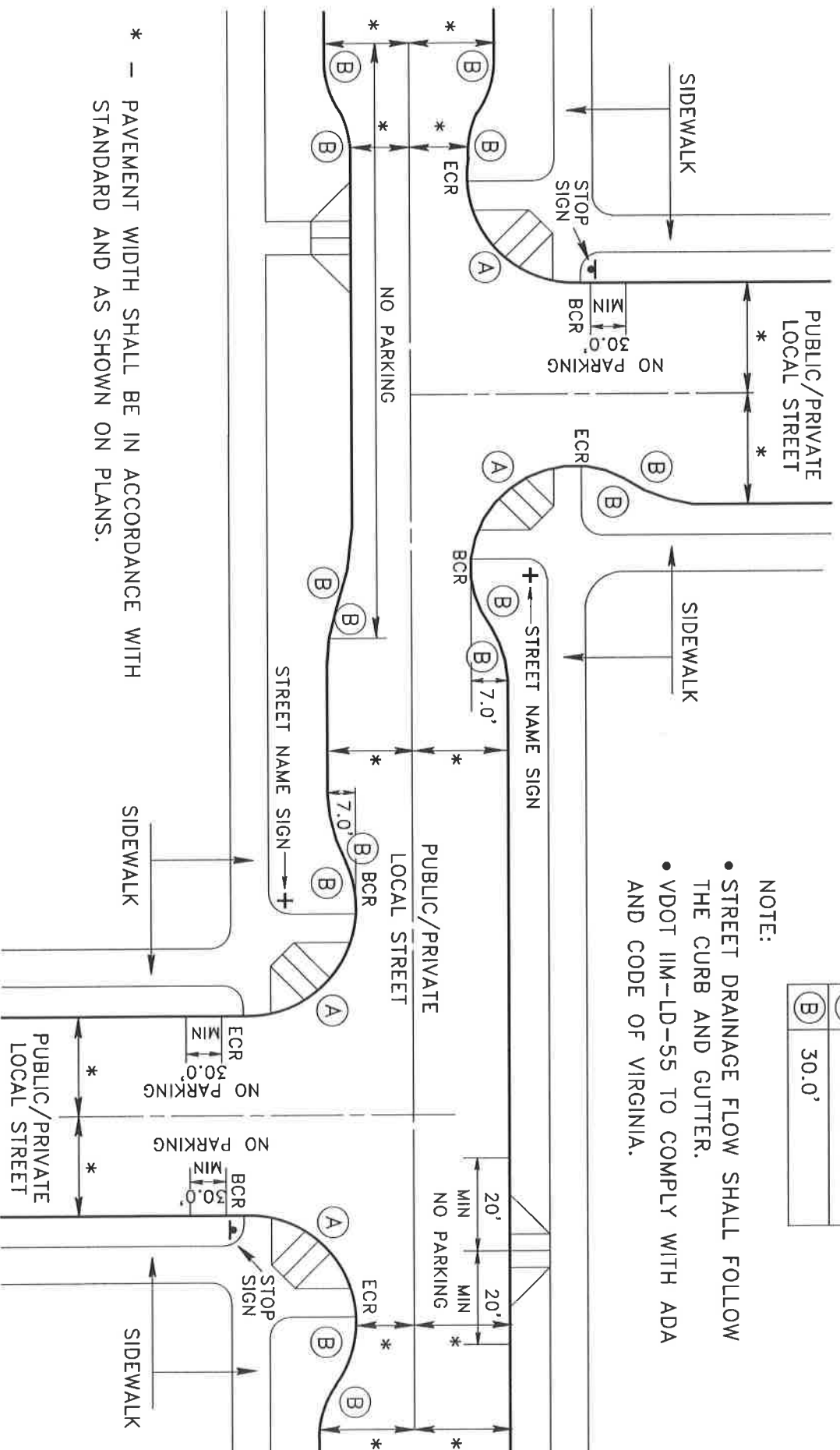

* - PAVEMENT WIDTH SHALL BE IN ACCORDANCE WITH STANDARD AND AS SHOWN ON PLANS.

Detail No.

650.20

CSL-1



COUNTY OF
PRINCE WILLIAM
VIRGINIA

CURB EXTENSION LAYOUT DESIGN

Date
7/15/14

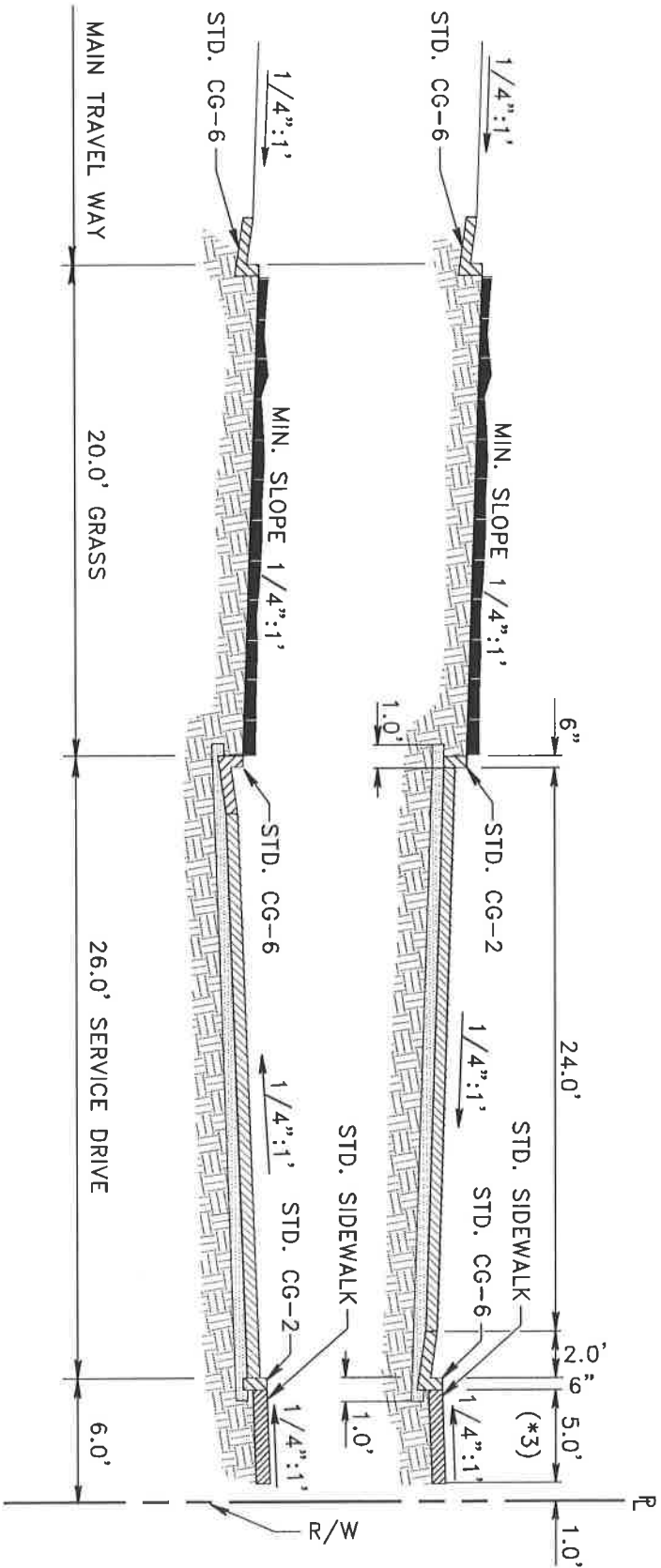

GENERAL NOTES:

- 1) Use pavement Category IV for this street standard.
- 2) Parking along service drive shall not be allowed.
- *3) Wider sidewalk or shared use path may be required by VDOT or County.

Detail No.	SD-1		COUNTY OF PRINCE WILLIAM VIRGINIA	STANDARD TYPICAL STREET SECTION WITH CURB AND GUTTER FOR SERVICE DRIVES	Date
650.21					7/15/14

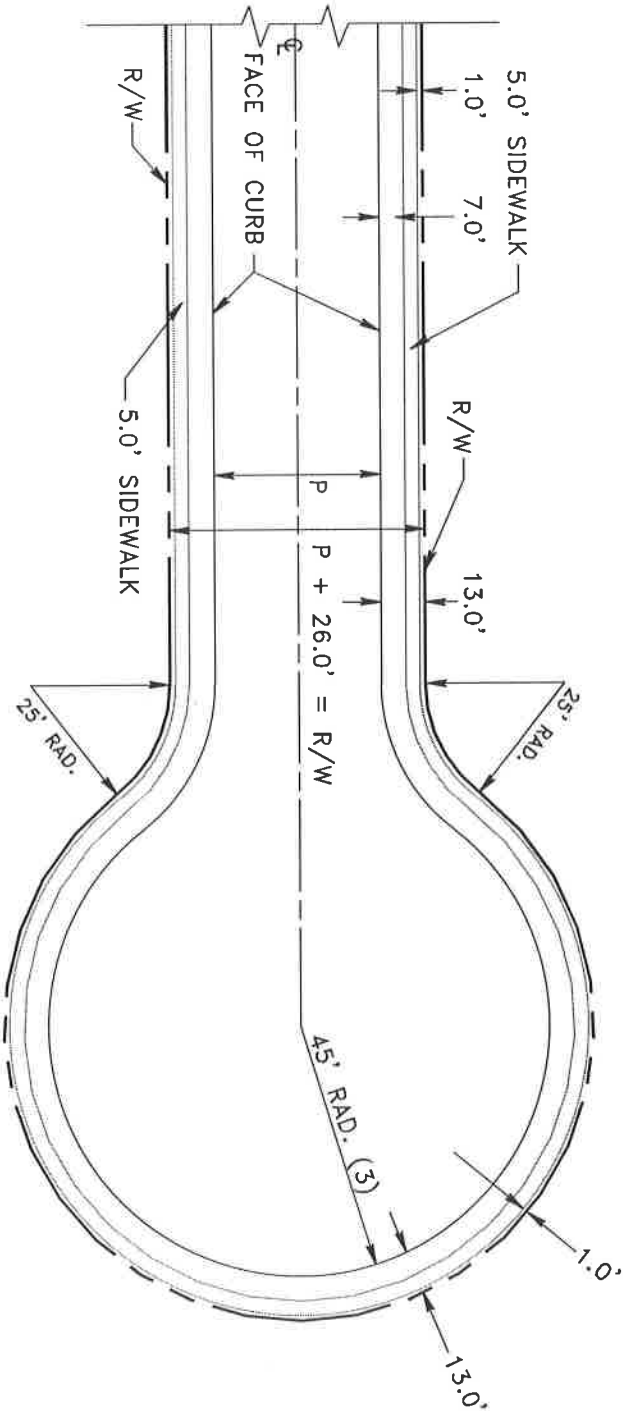

GENERAL NOTES:

- 1) If the cul-de-sac is determined by the County to be subject to regular bus or other large vehicle traffic, a larger pavement radius is required.
- 2) Minimum length of cul-de-sac is one lot width between the intersecting street and the beginning of the circular turn-around.
- 3) On category I residential streets, a minimum 30.0' radius may be acceptable. However, prior approval from Department of Fire & Rescue, School Board, Transportation, and VDOT shall be required. Parking along the cul-de-sac curb shall not be allowed and appropriate traffic control signs shall be provided.

Detail No.

650.22

CS-1



COUNTY OF
PRINCE WILLIAM
VIRGINIA

STANDARD CUL-DE-SAC WITH CURB,
GUTTER, AND SIDEWALK

Date

7/15/14

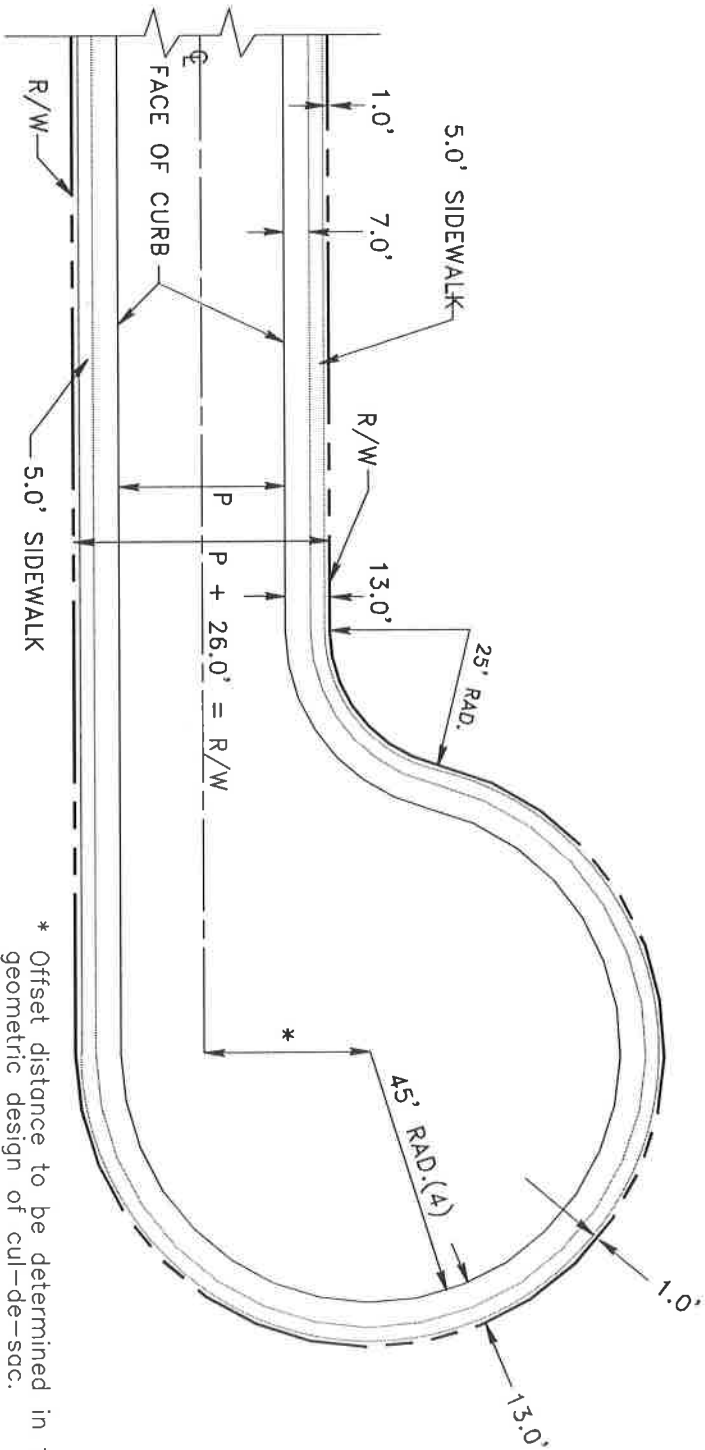

* Offset distance to be determined in the geometric design of cul-de-sac.

GENERAL NOTES:

- 1) If the cul-de-sac is determined by the County to be subject to regular bus or other large vehicle traffic, a larger pavement radius is required.
- 2) Minimum length of cul-de-sac is one lot width between the intersecting street and the beginning of the circular turn-around.
- 3) This type of offset cul-de-sac shall be used where the turnaround is subject to bus or other large vehicle traffic. Parking will not be permitted.
- 4) On category I residential streets, a minimum 30.0' radius may be acceptable. However, prior approval from Department of Fire & Rescue, School Board, Transportation, and VDOT shall be required. Parking along the cul-de-sac bulb shall not be allowed and appropriate traffic control signs shall be provided.

Detail No.			
650.23	CS-2		COUNTY OF PRINCE WILLIAM VIRGINIA
			OFFSET (LEFT) CUL-DE-SAC WITH CURB, GUTTER, AND SIDEWALK
		Date	7/15/14

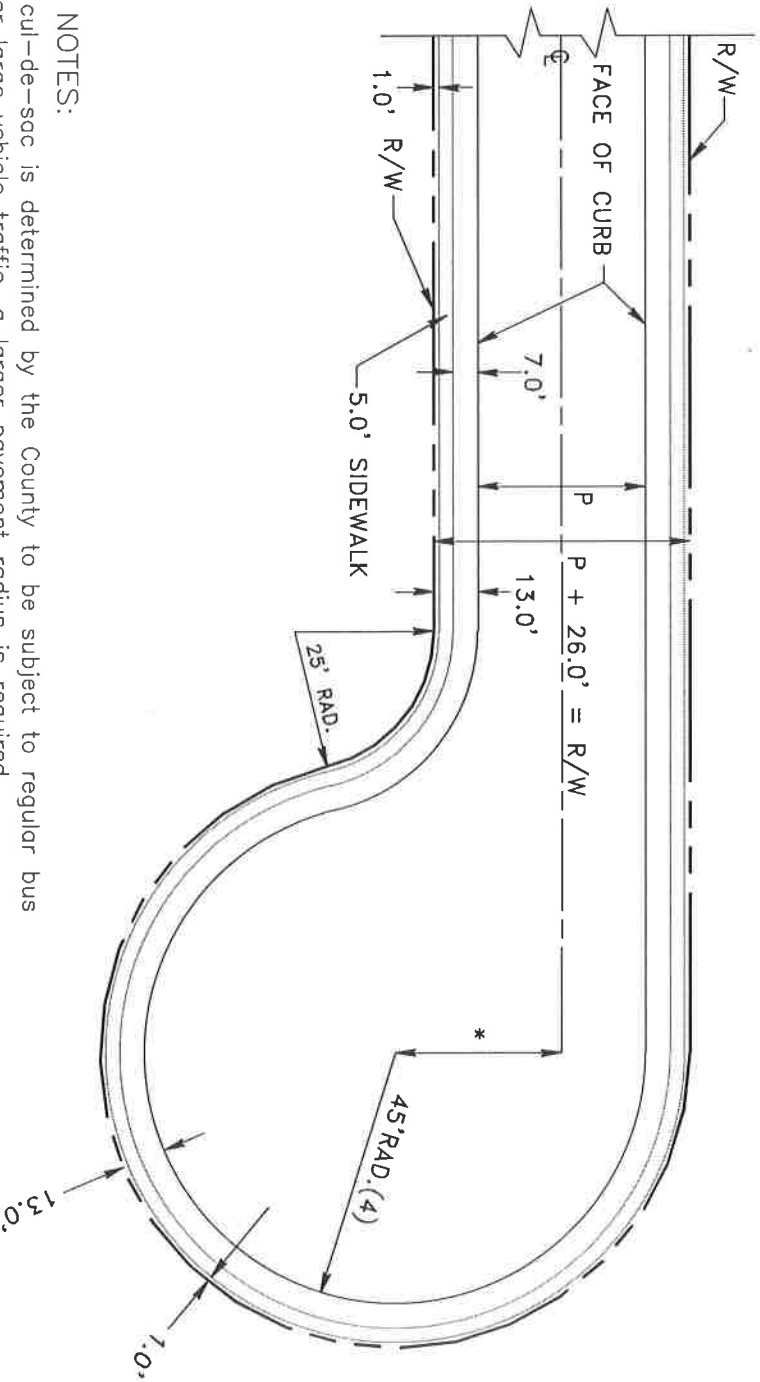

GENERAL NOTES:

- 1) If the cul-de-sac is determined by the County to be subject to regular bus or other large vehicle traffic, a larger pavement radius is required.
- 2) Minimum length of cul-de-sac is one lot width between the intersecting street and the beginning of the circular turn-around.
- 3) Design of cul-de-sac should consider counter-clockwise movement on the entry into the offset segment.
- 4) On category I residential streets, a minimum 30.0' radius may be acceptable. However, prior approval from Department of Fire & Rescue, School Board, Transportation, and VDOT shall be required. Parking along the cul-de-sac bulb shall not be allowed and appropriate traffic control signs shall be provided.

* Offset to be determined in the geometric design of cul-de-sac.

Detail No.	CS-3	COUNTY OF PRINCE WILLIAM VIRGINIA	OFFSET (RIGHT) CUL-DE-SAC WITH CURB, GUTTER, AND SIDEWALK
650.24			Date 7/15/14

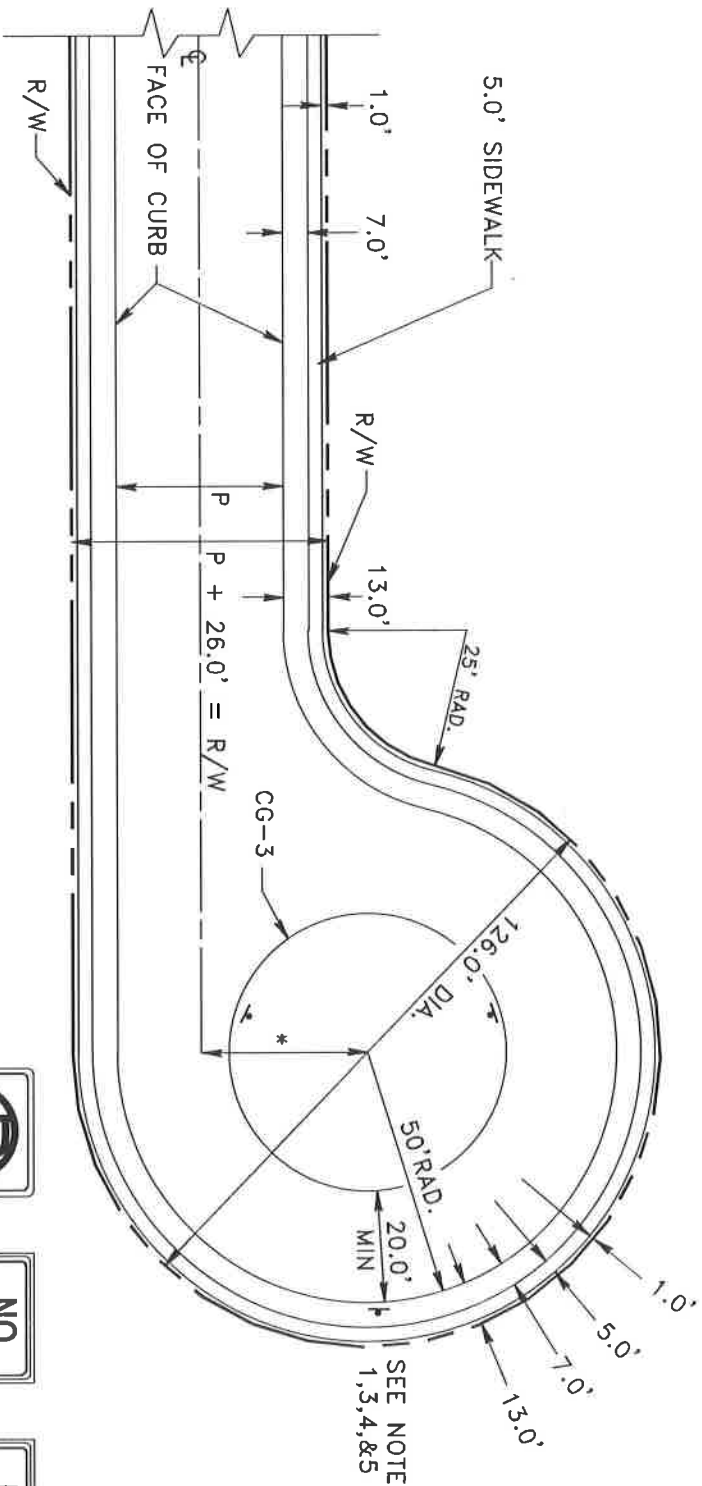

GENERAL NOTES:

- 1) If the cul-de-sac is determined by the County to be subject to regular bus or other large vehicle traffic, a larger pavement radius is required.
- 2) Minimum length of cul-de-sac is one lot width between the intersecting street and the beginning of the circular turn-around.
- 3) Design of cul-de-sac should consider counter-clockwise movement on the entry into the offset segment.
- 4) Parking along the cul-de-sac shall not be allowed. Appropriate traffic control (no parking, one-way, and do not enter) signs shall be installed prior to occupancy of any unit.
- 5) Lots along the cul-de-sac bulb shall be provided with three (3) off-street parking spaces exclusive of the garage or similar car shelter.



* Offset to be determined in the geometric design of cul-de-sac.

Detail No.

650.25

CCI-1



COUNTY OF
PRINCE WILLIAM
VIRGINIA

OFFSET CUL-DE-SAC WITH CURB,
GUTTER, AND SIDEWALK
(WITH CENTER ISLAND)

Date
7/15/14

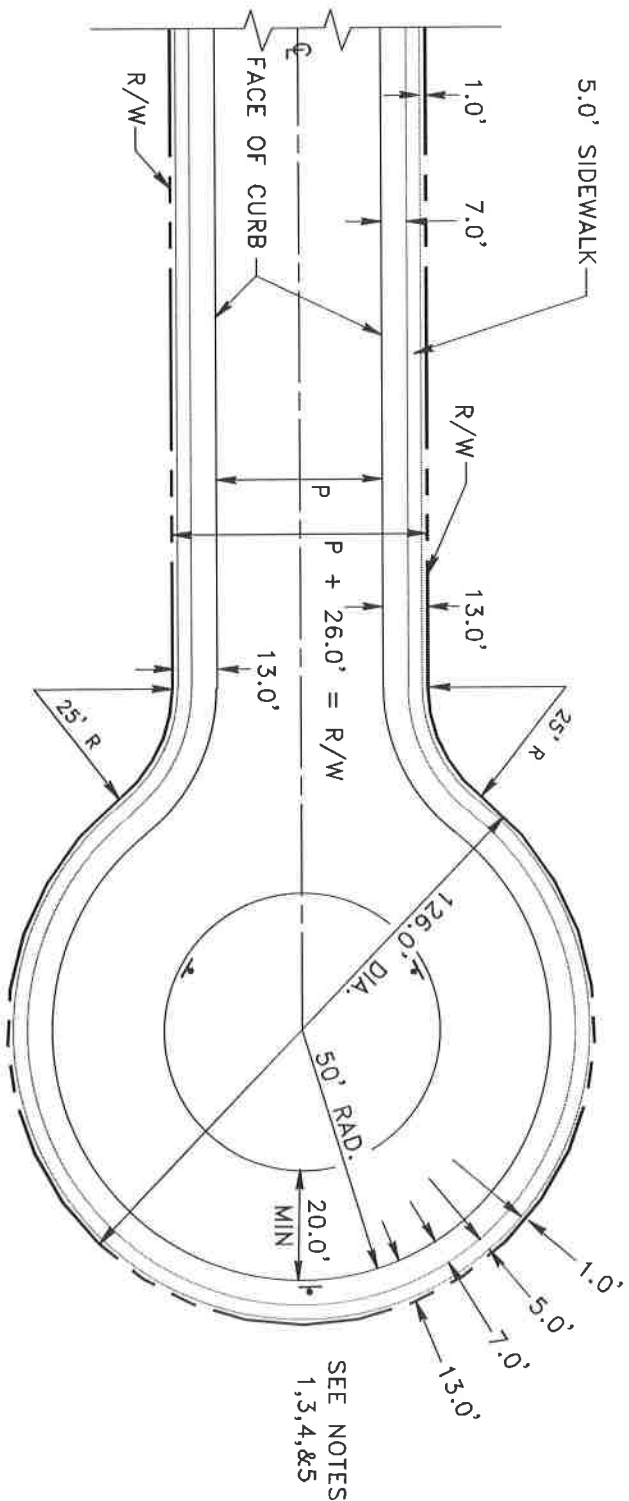

GENERAL NOTES:

- 1) If the cul-de-sac is determined by the County to be subject to regular bus or other large vehicle traffic, a larger pavement radius is required.
- 2) Minimum length of cul-de-sac is one lot width between the intersecting street and the beginning of the circular turn-around.
- 3) For industrial cul-de-sacs, the radius of pavement shall be fifty feet (50 ft.).
- 4) Parking along the cul-de-sac shall not be allowed. Appropriate traffic control (no parking, one-way, and do not enter) signs shall be installed prior to occupancy of any unit.
- 5) Lots along the cul-de-sac bulb shall be provided with three (3) off-street parking spaces exclusive of the garage or similar car shelter.



Detail No.
650.26

CCI-2



COUNTY OF
PRINCE WILLIAM
VIRGINIA

STANDARD CUL-DE-SAC WITH CURB,
GUTTER, AND SIDEWALK
(WITH CENTER ISLAND)

Date
7/15/14

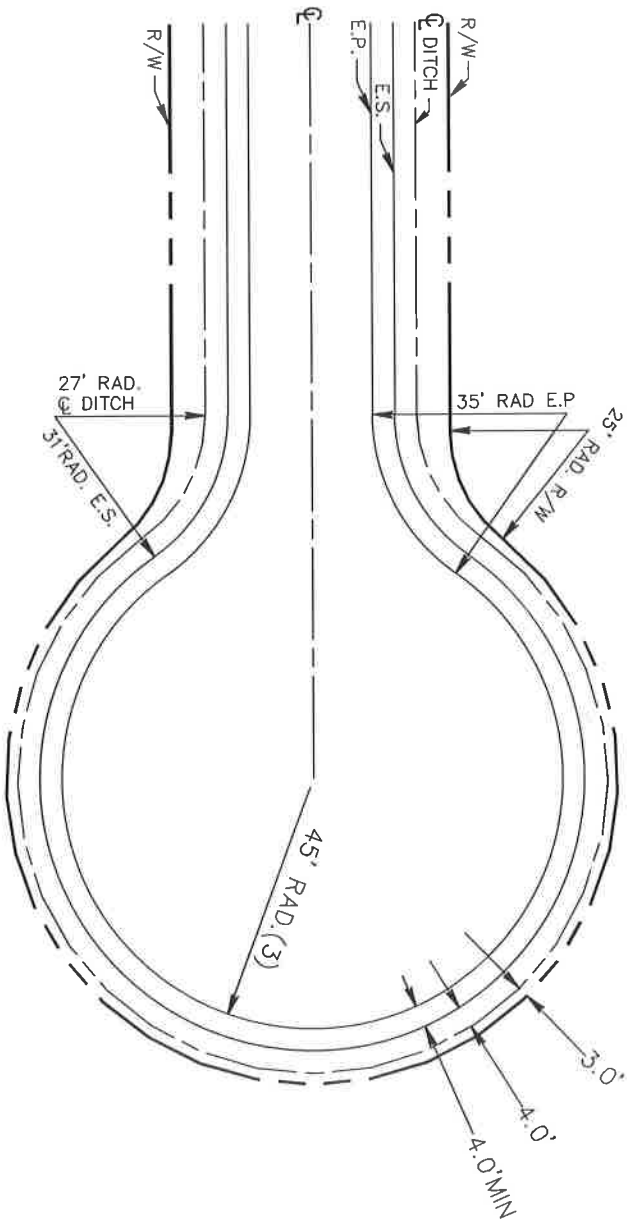

GENERAL NOTES:

- 1) If the cul-de-sac is determined by the County to be subject to regular bus or other large vehicle traffic, a larger pavement radius is required.
- 2) Minimum length of cul-de-sac is one lot width between the intersecting street and the beginning of the circular turn-around.
- 3) On category 1 residential streets, the minimum 30.0' radius may be acceptable. However, prior approval from Department of Fire & Rescue, School Board, Transportation and VDOT shall be required. Parking along the cul-de-sac bulb shall not be allowed and appropriate traffic control signs shall be provided.

Detail No.	DS-1		COUNTY OF PRINCE WILLIAM VIRGINIA	STANDARD CUL-DE-SAC ON DITCH SECTION STREET	
650.27					Date 7/15/14

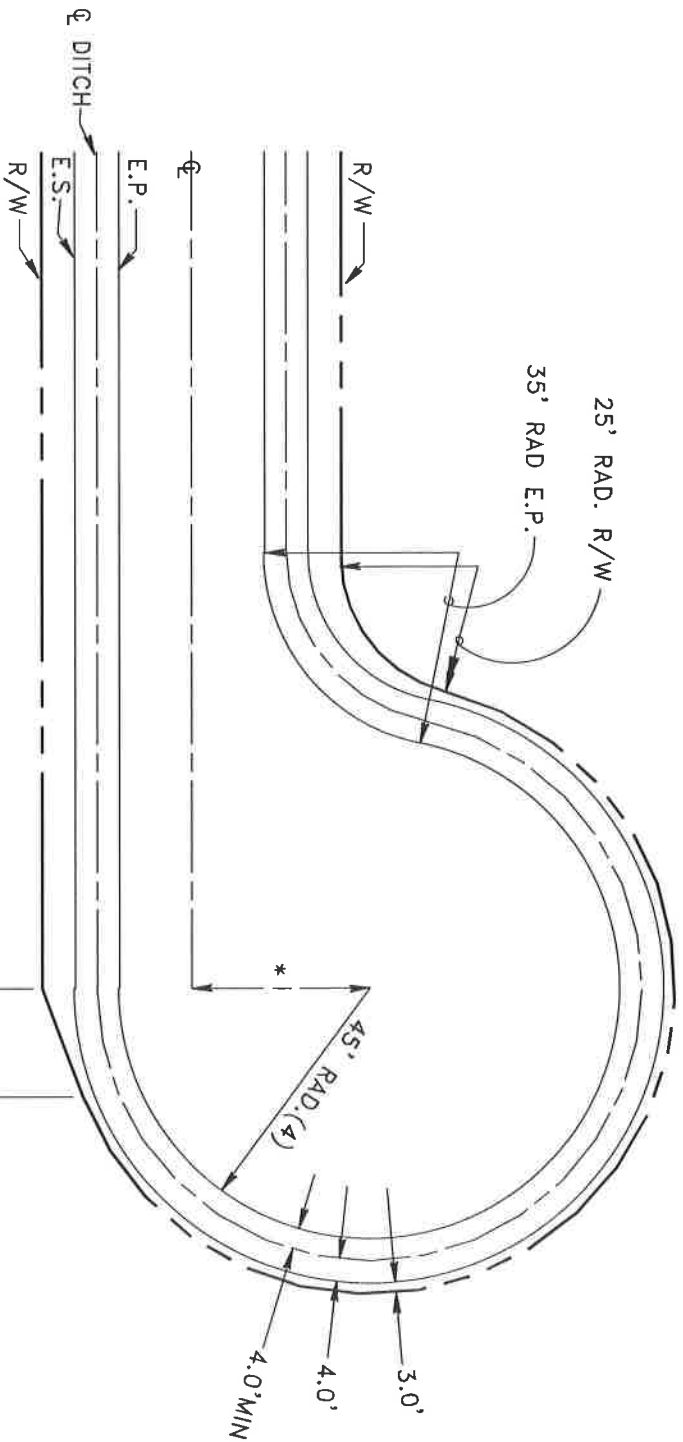

GENERAL NOTES:

- 1) If the cul-de-sac is determined by the County to be subject to regular bus or other large vehicle traffic, a larger pavement radius is required.
- 2) Minimum length of cul-de-sac is one lot width between the intersecting street and the beginning of the circular turn-around.
- 3) This type of offset cul-de-sac shall be used where the turnaround is subject to bus or other large vehicle traffic. Parking will not be permitted.
- 4) On category I residential streets, a minimum 30.0 radius may be acceptable. However, prior approval from Department of Fire & Rescue, School Board, Transportation and VDOT shall be required. Parking along the cul-de-sac bulb shall not be allowed and appropriate traffic control signs shall be provided.

* Offset distance to be determined in the geometric design of cul-de-sac.

Detail No.	650.28	DS-2		COUNTY OF PRINCE WILLIAM VIRGINIA	OFFSET (LEFT) CUL-DE-SAC ON DITCH SECTION STREET	Date 7/15/14
------------	--------	------	--	---	---	-----------------

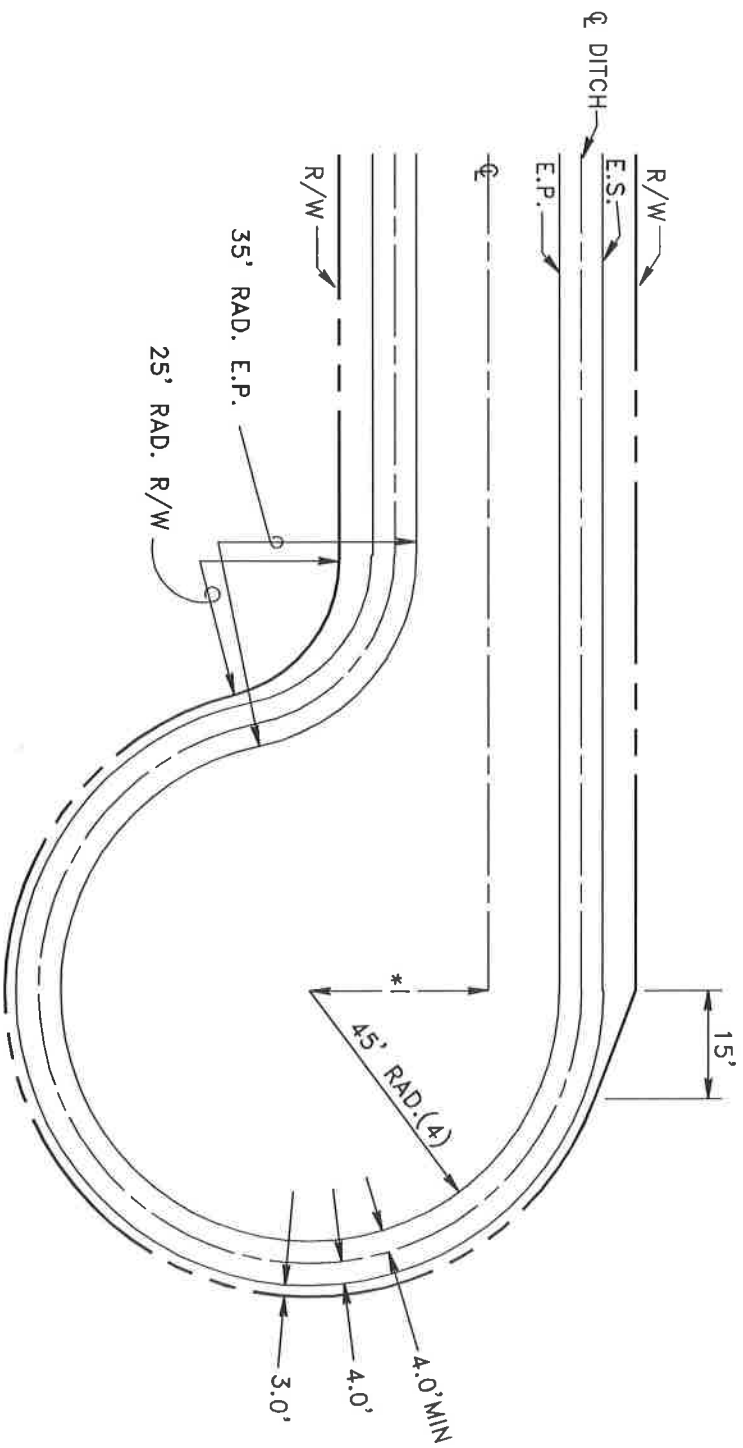

GENERAL NOTES:

- 1) If the cul-de-sac is determined by the County to be subject to regular bus or other large vehicle traffic, a larger pavement radius is required.
- 2) Minimum length of cul-de-sac is one lot width between the intersecting street and the beginning of the circular turn-around.
- 3) Design of cul-de-sac should consider counter-clockwise movement on the entry into the offset segment.
- 4) On category 1 residential streets, a minimum 30.0' radius may be acceptable. However, prior approval from Department of Fire & Rescue, School Board, Transportation and VDOT shall be required. Parking along the cul-de-sac bulb shall not be allowed and appropriate traffic control signs shall be provided.

* Offset distance to be determined in the geometric design of the cul-de-sac.

Detail No.	DS-3		COUNTY OF PRINCE WILLIAM VIRGINIA	OFFSET (RIGHT) CUL-DE-SAC ON DITCH SECTION STREET	
650.29					Date 7/15/14

GEOMETRICAL SHAPE #1

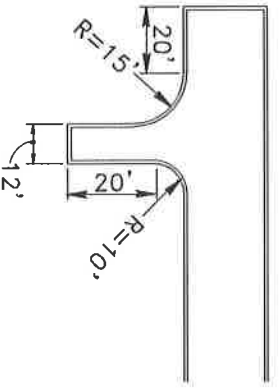

PAVING SECTION TO BE SAME AS STREET

GEOMETRICAL SHAPE #2

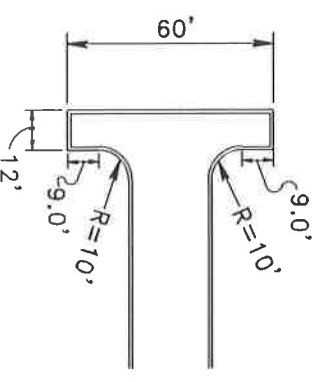

PAVING SECTION TO BE SAME AS STREET

GEOMETRICAL SHAPE #3

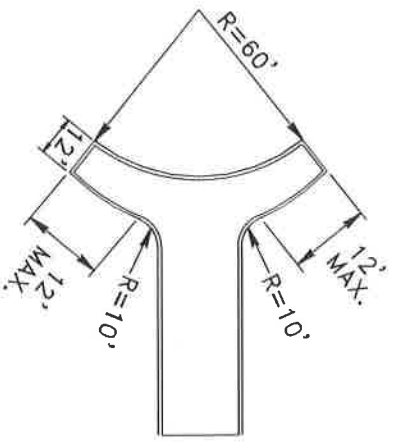

PAVING SECTION TO BE SAME AS STREET

GEOMETRICAL SHAPE #4

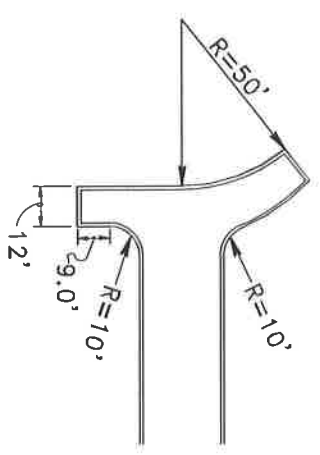

PAVING SECTION TO BE SAME AS STREET

NOTE: ABOVE DESIGNS ARE MINIMUM REQUIREMENTS. DESIGNS CONFORMING TO VDOT'S MINIMUM REQUIREMENTS WHICHEVER IS MORE STRINGENT SHALL BE PROVIDED.

Detail No.

650.30

TT-1



COUNTY OF PRINCE WILLIAM VIRGINIA

TRAVELWAY TURNAROUND STANDARDS

Date 7/15/14

GEOMETRIC SHAPE #1

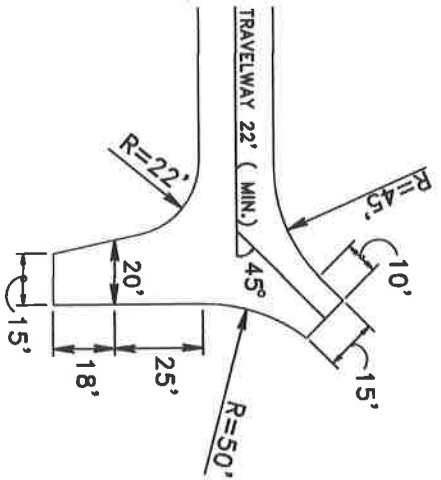

GEOMETRIC SHAPE #2

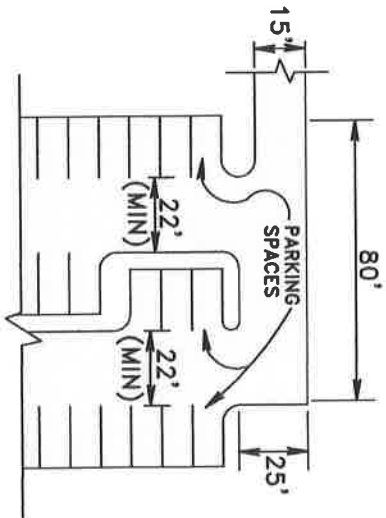

GEOMETRIC SHAPE #3

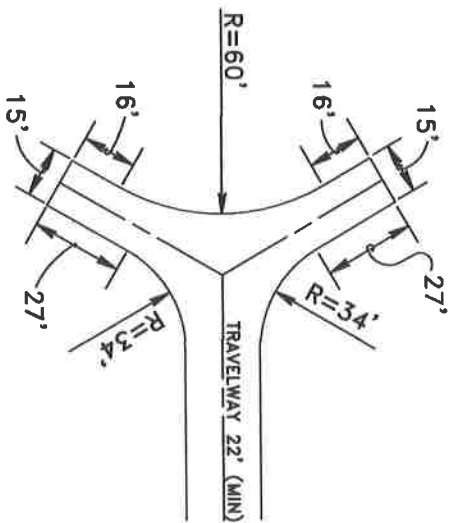

GEOMETRIC SHAPE #4
FOR SERVICE VEHICLES ONLY

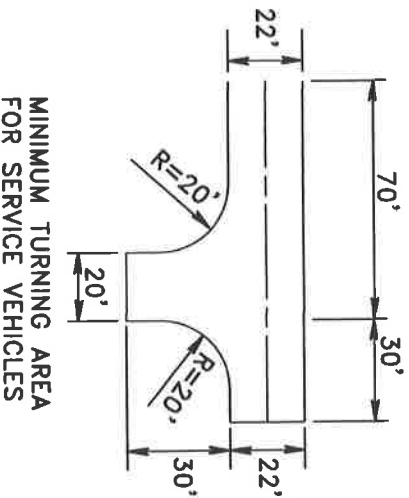

MINIMUM TURNING AREA FOR EMERGENCY VEHICLES

GENERAL NOTES:

- 1) Design based on 45 ft. design vehicle for emergency vehicles and single unit trucks for service vehicles.
- 2) Geometric shapes shown are guidelines only. Other designs shall require prior approval.
- 3) The turnarounds (Geometric shapes #1-#3) shall be provided when the length of the private travelway or street exceeds 250 feet measured from the face of curb of the driveway entrance to the edge of the driveway of the last dwelling unit. Turnaround (Geometric shape #4) shall be required where the length is 100-250 feet.
- 4) "No Parking" signs shall be required in the turning area and where required.
- 5) Above designs are minimum requirements. Designs conforming to VDOT's minimum requirements or whichever is more stringent shall be provided.

Detail No.
650.31

TT-2



COUNTY OF
PRINCE WILLIAM
VIRGINIA

TRAVELWAY TURNAROUND FOR
EMERGENCY VEHICLES AND
SERVICE TRUCKS

Date
6/26/18

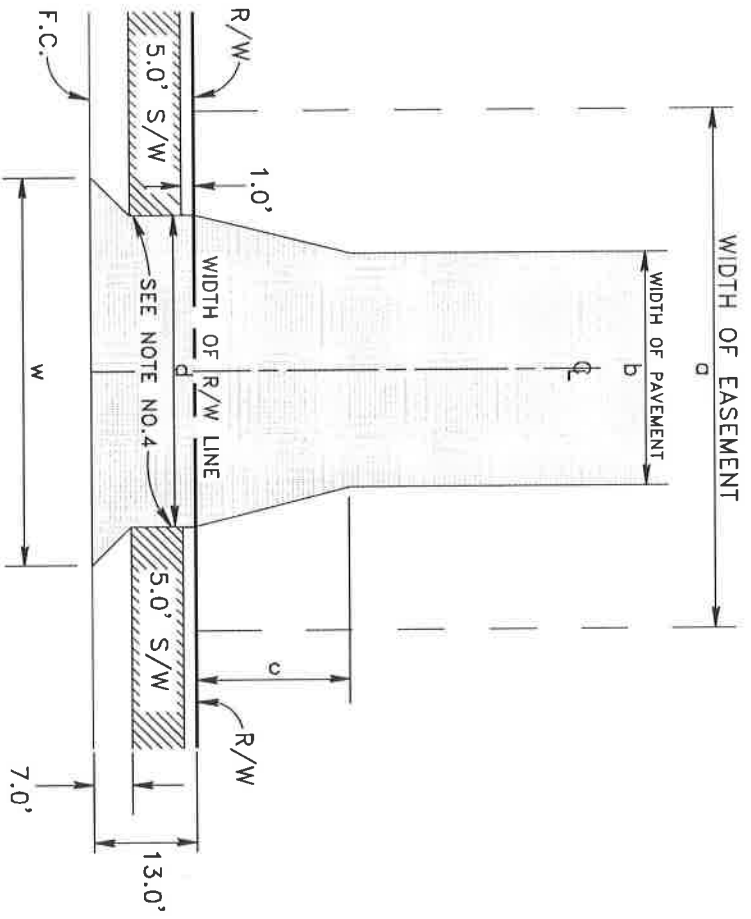

NUMBER OF LOTS	a (ft)	b (ft)	c (ft)	d (ft)	w (ft)
1	18	10			
				STD. DE-2	
2-5	40	18	12	24	28

GENERAL NOTES:

- 1) For pavement design refer to Detail 650.01.
- 2) Two percent (2%) landing required for first twenty (20) feet.
- 3) For ditch section also refer to detail 650.38 for DE-4.
- 4) The entrance section of the driveway within the right-of-way limits should be designed in accordance with the alternative entrance with curb and gutter standard DE-2 or CG-9D standard of VDOT.
- 5) Design of entrance apron shall conform to County or VDOT requirements whichever is more stringent.

Detail No.	650.32	PP-1		COUNTY OF PRINCE WILLIAM VIRGINIA	PIPESTEM ENTRANCE DESIGN WITH CURB AND GUTTER	Date 7/15/14
------------	--------	------	--	-----------------------------------	---	-----------------

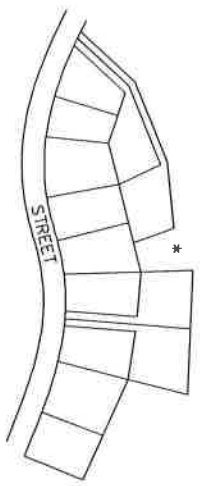

A

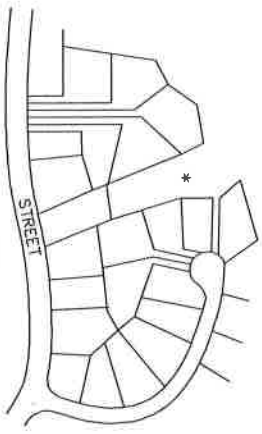

B

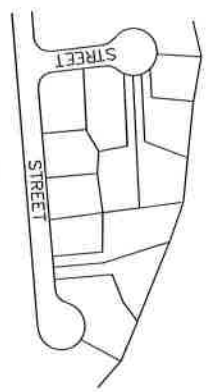

C

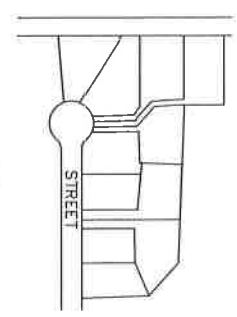

D

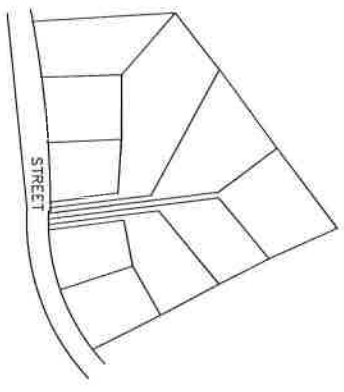

E

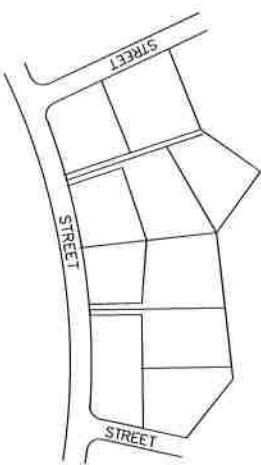

F

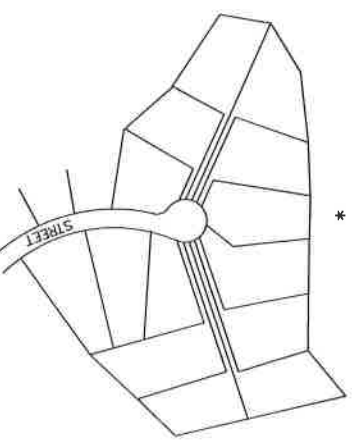

G

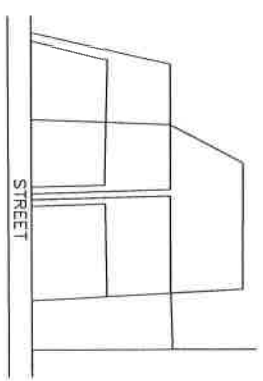

H

NOTE:
 * Indicates minimum separation of one hundred feet (100 ft.).

Detail No.

650.33

PP-2



COUNTY OF
 PRINCE WILLIAM
 VIRGINIA

TYPICAL ACCEPTABLE PIPESTEM
 LOTS LAYOUT (DOUBLE STACKING)
 SHEET 1 OF 2

Date
 7/15/14

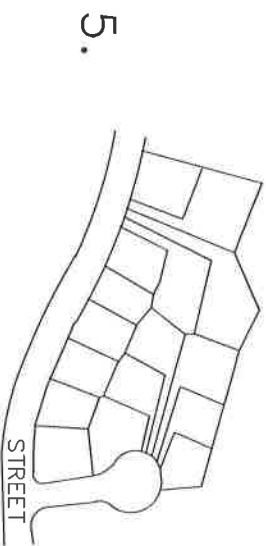
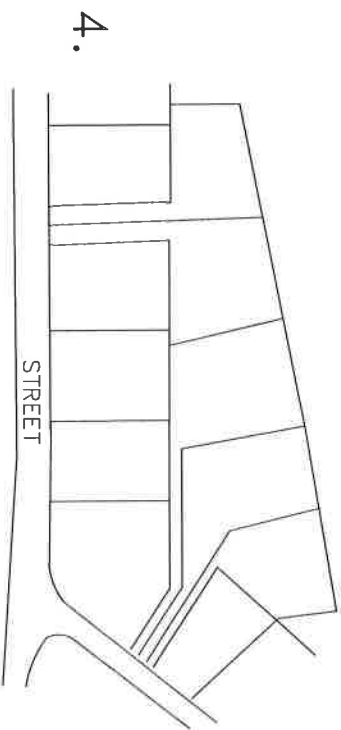
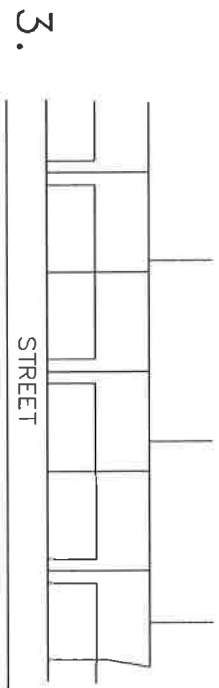
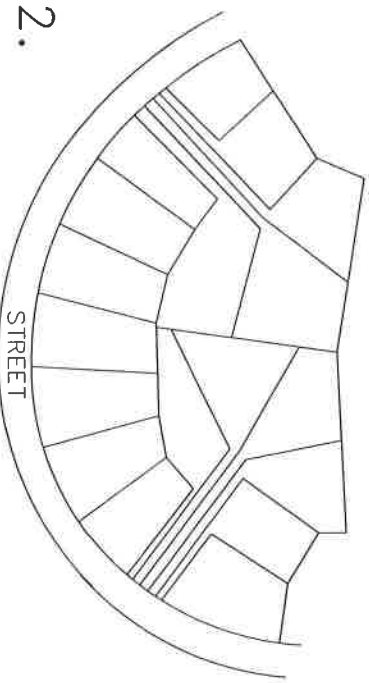
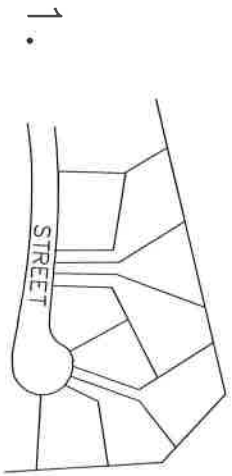

GENERAL NOTES:

1. Layouts Nos. 1-5 are typical pipestem layouts not acceptable to the County.
2. All pipestem layouts should be designed conforming to Detail 650.33(A) of this manual.

Detail No.	PP-2		COUNTY OF PRINCE WILLIAM VIRGINIA	TYPICAL ACCEPTABLE PIPESTEM LOTS LAYOUT (DOUBLE STACKING) SHEET 2 OF 2	
650.33					Date 7/15/14

Detail No.

650.34

IL-1



COUNTY OF PRINCE WILLIAM VIRGINIA

INTERSECTION LANDING REQUIREMENTS

Date 7/15/14

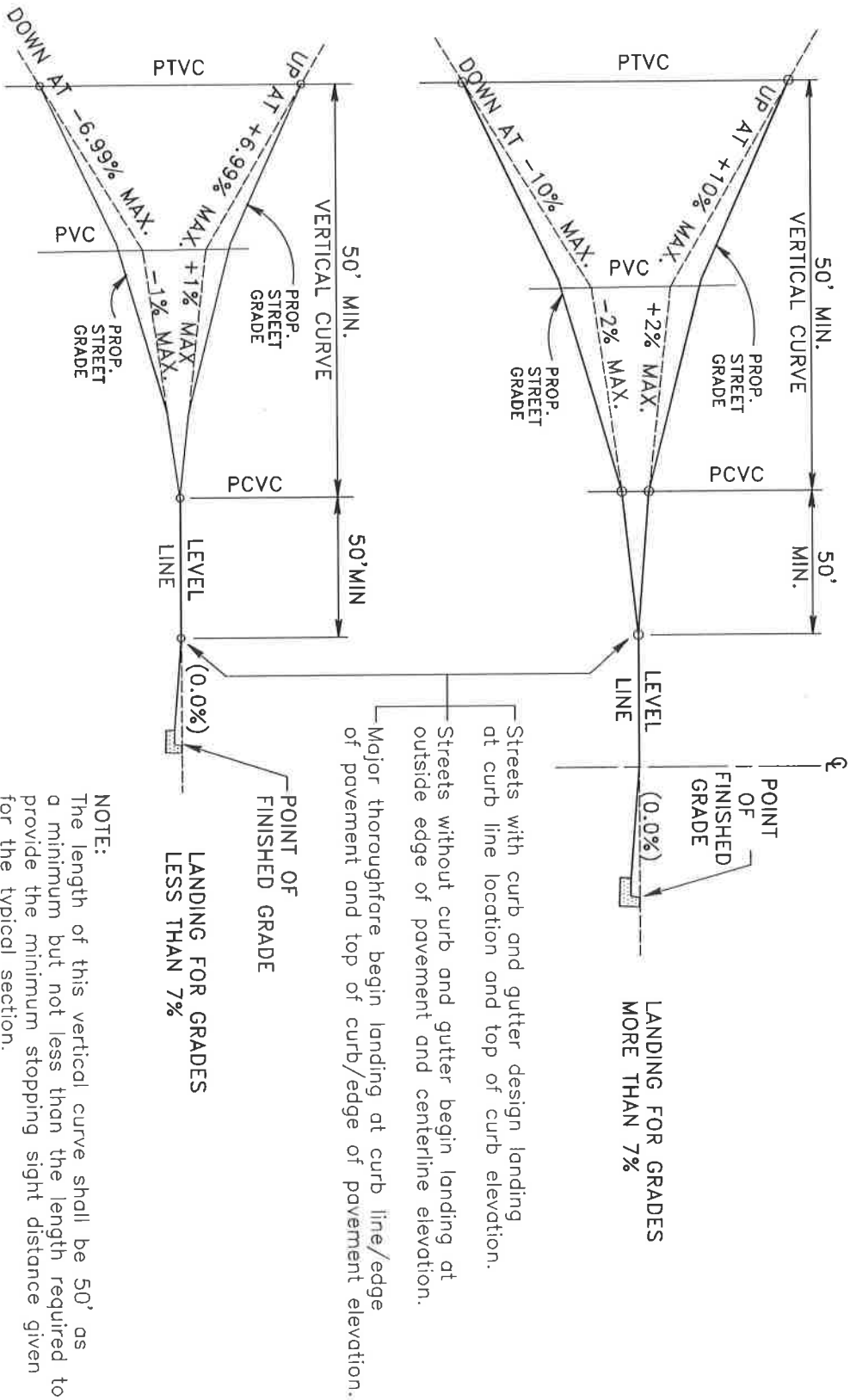

NOTE:
 The length of this vertical curve shall be 50' as a minimum but not less than the length required to provide the minimum stopping sight distance given for the typical section.

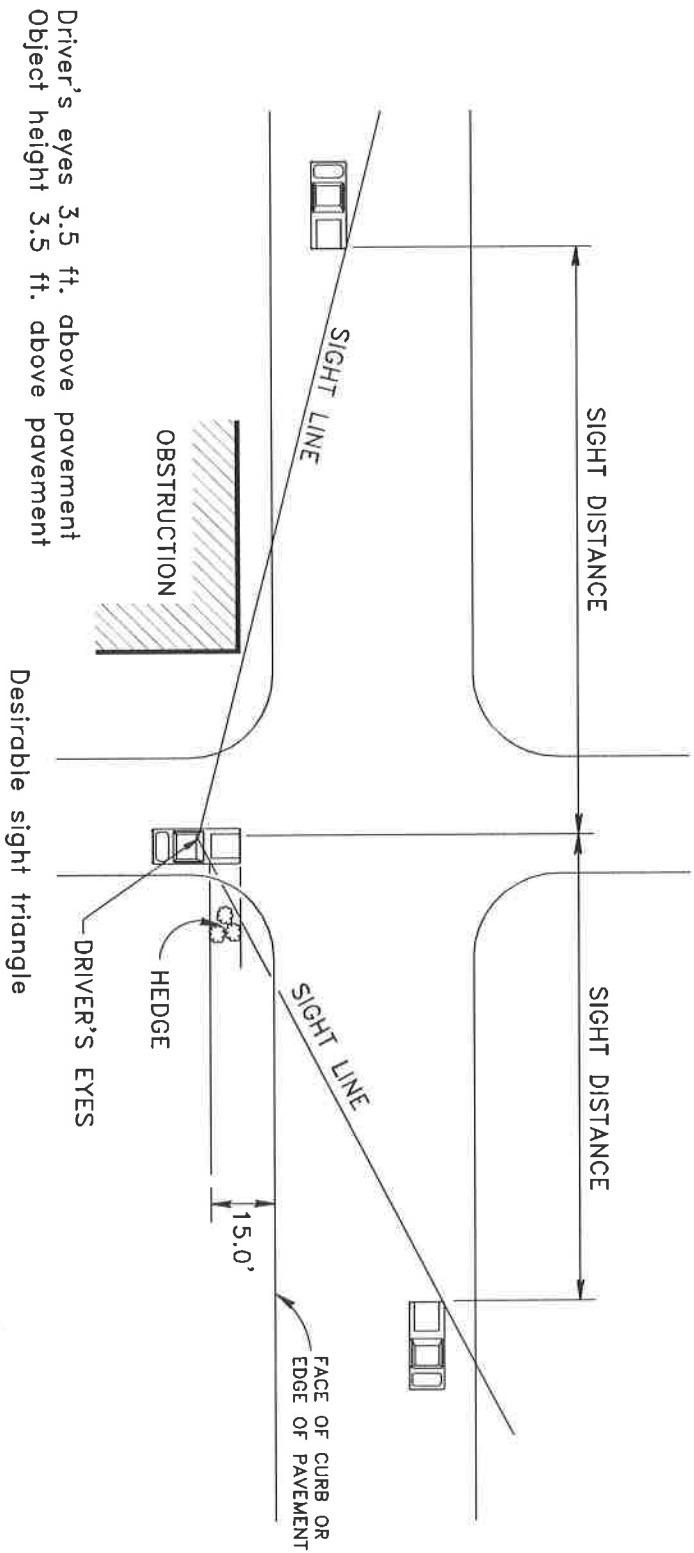

General Notes:

- 1) The profile of the sight line shall be required.
- 2) Driver's Eyes are 3.5 ft. above the pavement.
- 3) Object height is 3.5 ft. above the pavement.

Detail No.	ISD-1	 COUNTY OF PRINCE WILLIAM VIRGINIA	INTERSECTION SIGHT DISTANCE REQUIREMENTS	Date
650.35				7/15/14

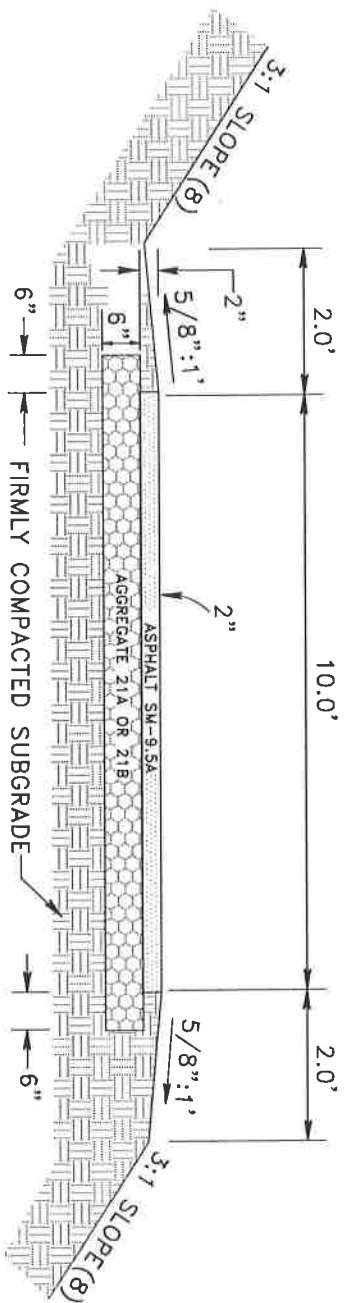

MINIMUM RADII FOR PAVED BICYCLE PATHS			
e = 2% (Percent) minimum			
DESIGN SPEED - V (mph)	FRICTION FACTOR - F	MINIMUM RADIUS - R (feet)	
20	0.27	100	
25	0.25	155	

GENERAL NOTES:

- 1) Maximum grades must conform to maximum allowed street grades. Minor variations from the following may be permitted with approval:
 - 10 percent for length up to 100 feet
 - 5 percent for length up to 300 feet
 - 2 percent for length up to 1500 feet
- 2) Minimum horizontal radius of curvature is fifteen feet (15').
- 3) Minimum horizontal clearance of fourteen feet (14.0') total.
- 4) Minimum vertical clearance of ten feet (10').
- 5) Pavement cross-slope of 1/4 in.:1 ft. required. Pavement surface may be crowned in the middle or sloped to one side.
- 6) Maximum design speed shall be 25 MPH.
- 7) Super-elevation shall be used on all curves following the rates specified in the above table.
- 8) A side slope of 2:1 will be allowed where special stabilization is provided in accordance with the Erosion Control ordinance.
- 9) Profile shall be shown on plans when required by the Department of Public Works.
- 10) Base layer (21A or 21B) shall be primed with liquid asphalt at 0.4 gals./s.y. in accordance with VDOT I&I LD - 91(D) 157.3.
- 11) Standard UD-3 shall be used when the longitudinal gradient is three percent (3%) or more and when the underlying soil has 34% or more passing the Number 200 sieve and has a P.I. of 13 or less.
- 12) For Design, Drainage, and other Specifications not in this manual, refer to current VDOT Standards and/or AASHTO Manual for the development of bicycle facilities.

Detail No.	BT-1	<p style="text-align: center; margin: 0;">COUNTY OF PRINCE WILLIAM VIRGINIA</p>	<p style="margin: 0;">BICYCLE TRAIL/SHARED USE PATH STANDARDS FOR VDOT MAINTENANCE</p>	Date 7/15/14
650.36				

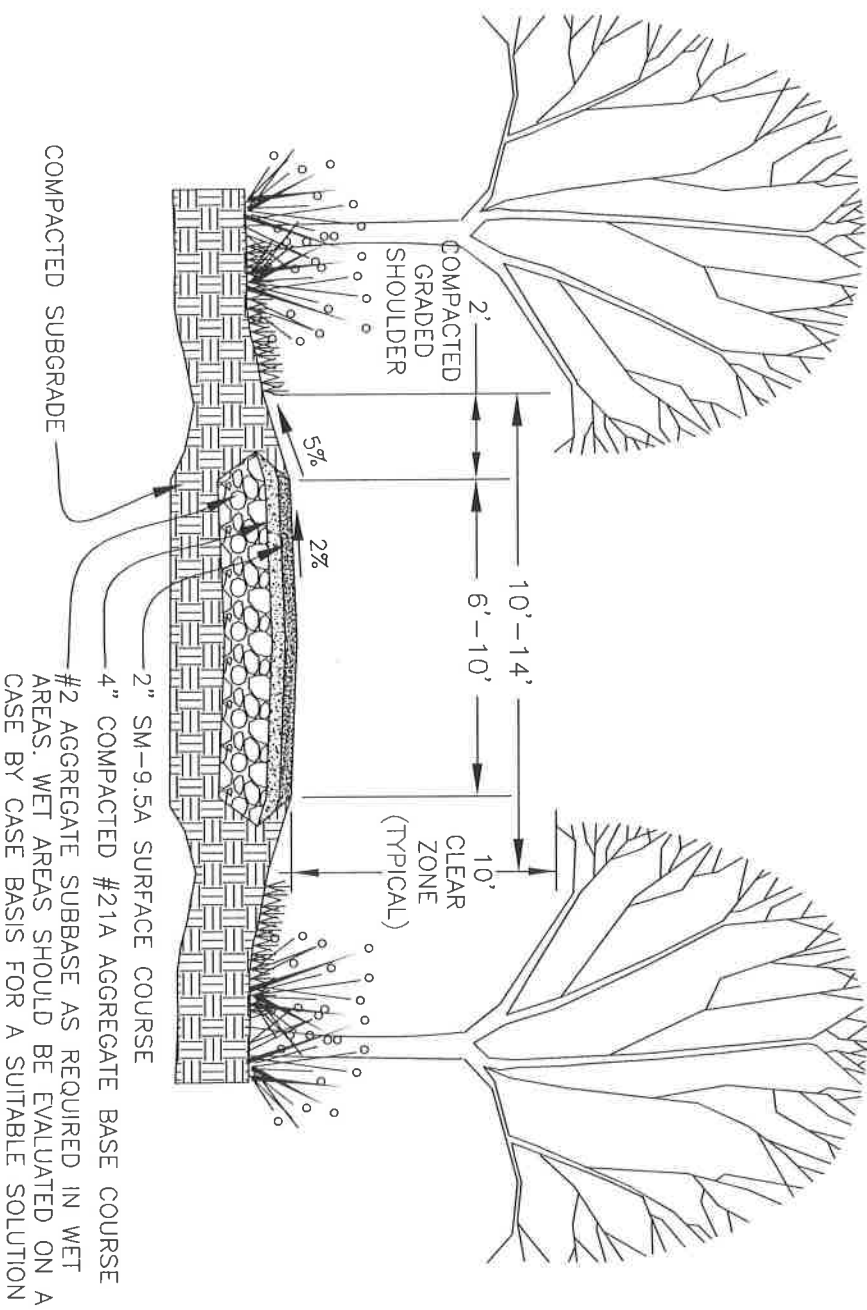

GENERAL NOTES:

- 1) Minimum easement width shall be fifteen feet (15.0'). Additional easement width may be required due to topography or other existing conditions.
- 2) Subgrade shall be compacted to 95 percent maximum density per AASHTO T-99 or ASTM D-698 standards at the optimum moisture content. Base layer and surface layer shall be compacted to the density in accordance with VDOT standards.
- 3) Final grade can vary according to individual sites. Trail location shall be routed to minimize land disturbance.
- 4) Standard UD-3 shall be utilized when the longitudinal gradient is three percent (3%) or more or when the underlying soil has 34 percent or more passing the Number 200 sieve and has a P.I. of thirteen (13) or less.
- 5) Signs indicating "not for motorized vehicles" shall be provided.
- 6) All pedestrian and hiker trails that connect public facilities must be accessible.

Detail No.			
650.37	PT-1	 <p>COUNTY OF PRINCE WILLIAM VIRGINIA</p>	<p>ASPHALT PARK TRAIL (NOT ELIGIBLE FOR VDOT MAINTENANCE)</p>
			Date 7/15/14

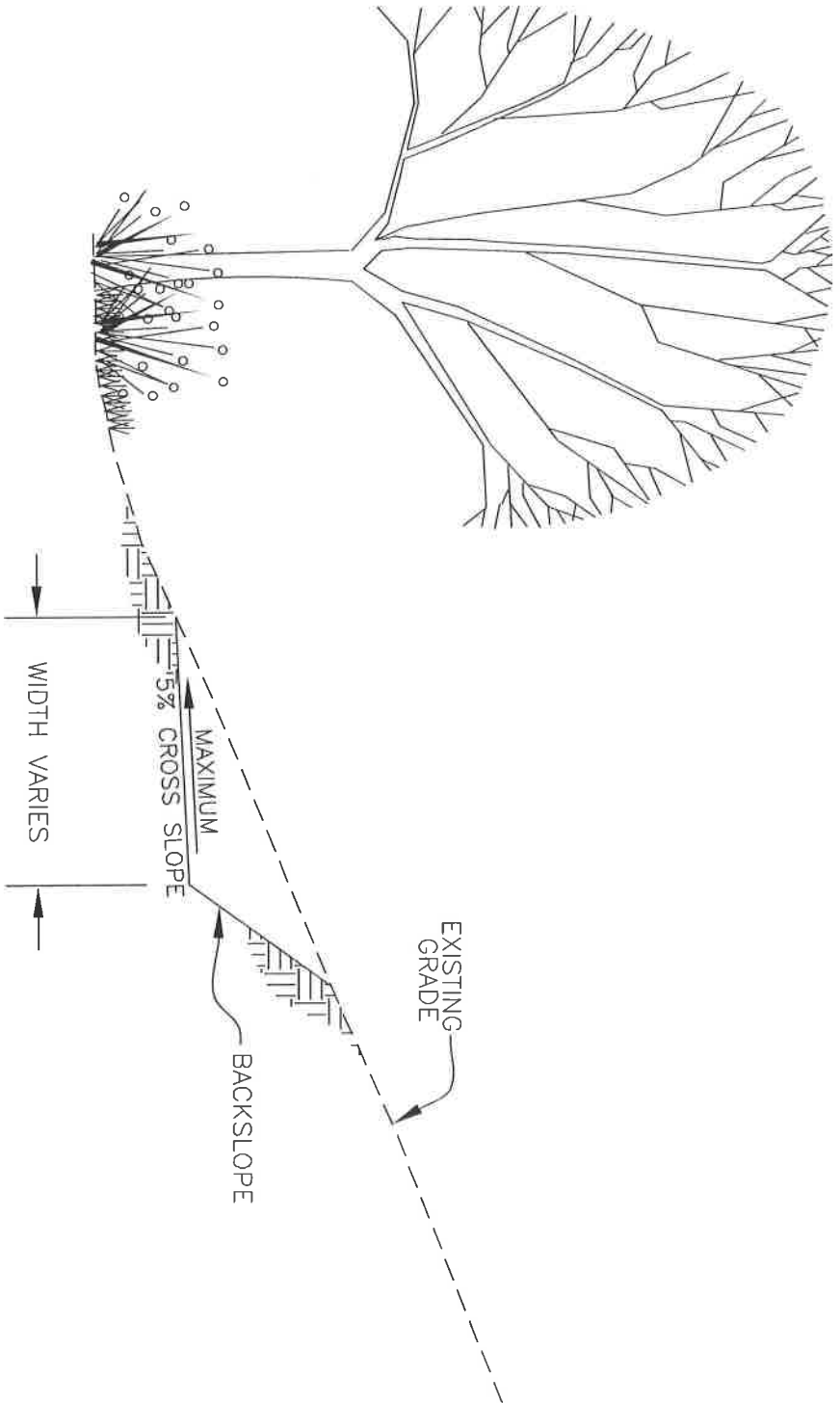

NOTES:

- 1) Minimum easement width shall be fifteen feet (15.0'). Additional easement width may be required due to topography or other existing conditions.
- 2) Final grade and tread width can vary according to individual sites. Trail location shall be routed to minimize land disturbance.
- 3) The proposed backslope shall be blended into the existing grade as gradual as possible. Stabilization may be required.
- 4) See Details 650.37, 650.39, and 650.40 for the width of trail.

Detail No.	COUNTY OF PRINCE WILLIAM VIRGINIA		FULL BENCH CUT TRAIL (NOT ELIGIBLE FOR VDOT MAINTENANCE)	Date 7/15/14
650.38	CT-1			

GENERAL NOTES:

- 1) Minimum easement width shall be fifteen feet (15.0') centered on the trail. Additional easement width may be required due to topography or other existing conditions.
- 2) Subgrade shall be compacted to 95 percent maximum density per AASHTO T-99 or ASTM D-698 standards at the optimum moisture content.
- 3) Final grade can vary according to individual sites. Trail location shall be routed to minimize land disturbance.
- 4) #2 aggregate subbase, as required in wet areas. Wet areas should be evaluated on a case by case basis for a suitable solution.
- 5) All pedestrian and hiker trails that connect public facilities must be accessible.

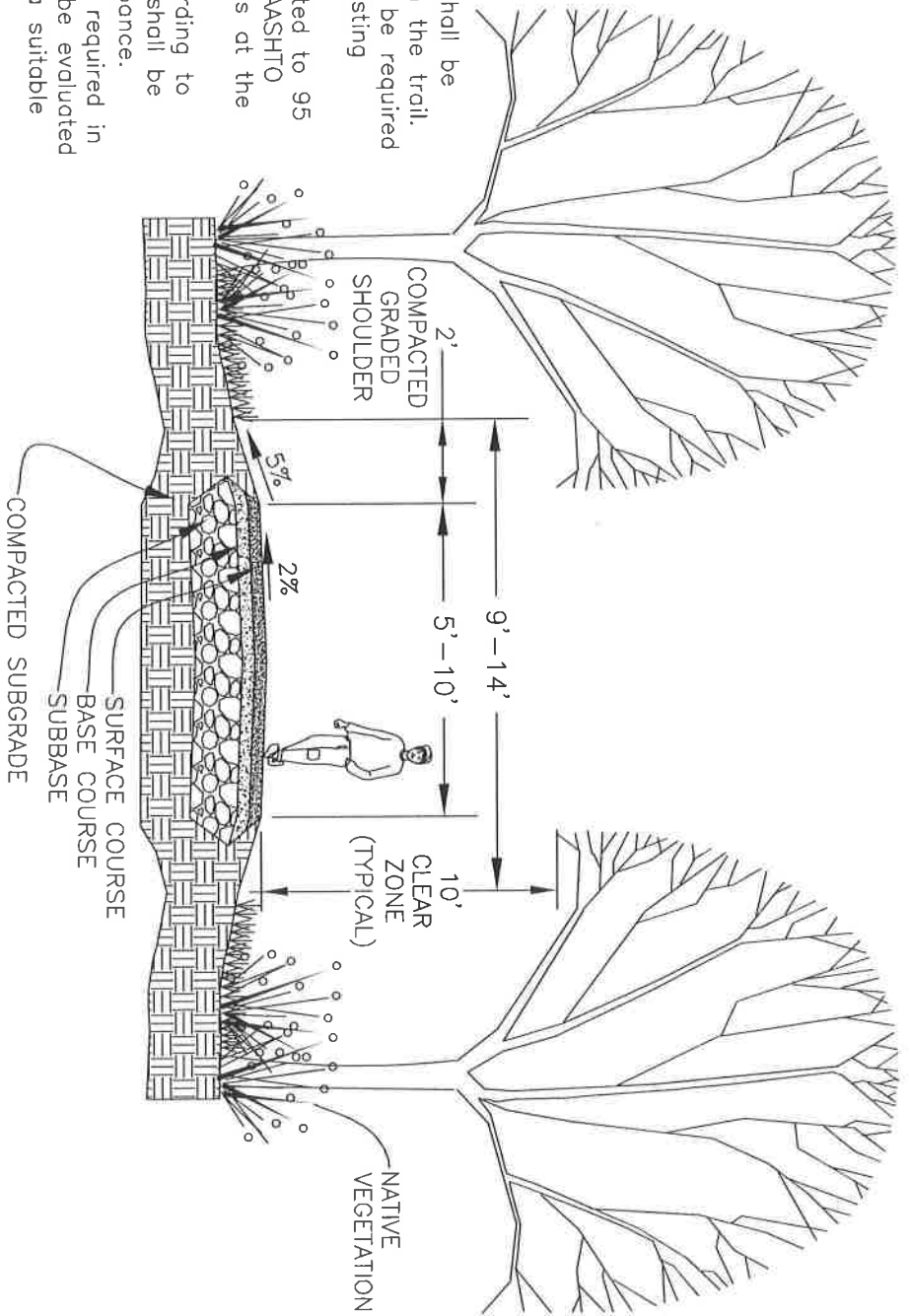

TYPE	TRAIL WIDTH (ft)	TRAIL CROSS SLOPE	SHOULDER WIDTH (ft)	SHOULDER CROSS SLOPE	SUBBASE AGG. BASE	BASE	SURFACE
NATURAL	4-10	2%	2	5%	-	-	Denuded and Compacted Subgrade
STONE DUST	6-10	2%	2	5%	See Note 4	3 in. Stone	3 in. Stone Dust or Blue Chip Stone
WOOD CHIP	6-10	2%	2	5%	-	-	6 in. Wood Chips

Detail No.

650.39

HT-1



COUNTY OF
PRINCE WILLIAM
VIRGINIA

HIKING TRAIL
(NOT ELIGIBLE FOR VDOT MAINTENANCE)

Date
7/15/14

GENERAL NOTES:

- 1) Minimum easement width shall be fifteen feet (15.0'). Additional easement width may be required due to topography or other existing conditions.
- 2) Subgrade shall be compacted to 95 percent maximum density per AASHTO T-99 or ASTM D-698 standards at the optimum moisture content.
- 3) Final grade can vary according to individual sites. Trail location shall be routed to minimize land disturbance.
- 4) #2 aggregate subbase, as required in wet areas. Wet areas should be evaluated on a case by case basis for a suitable solution.

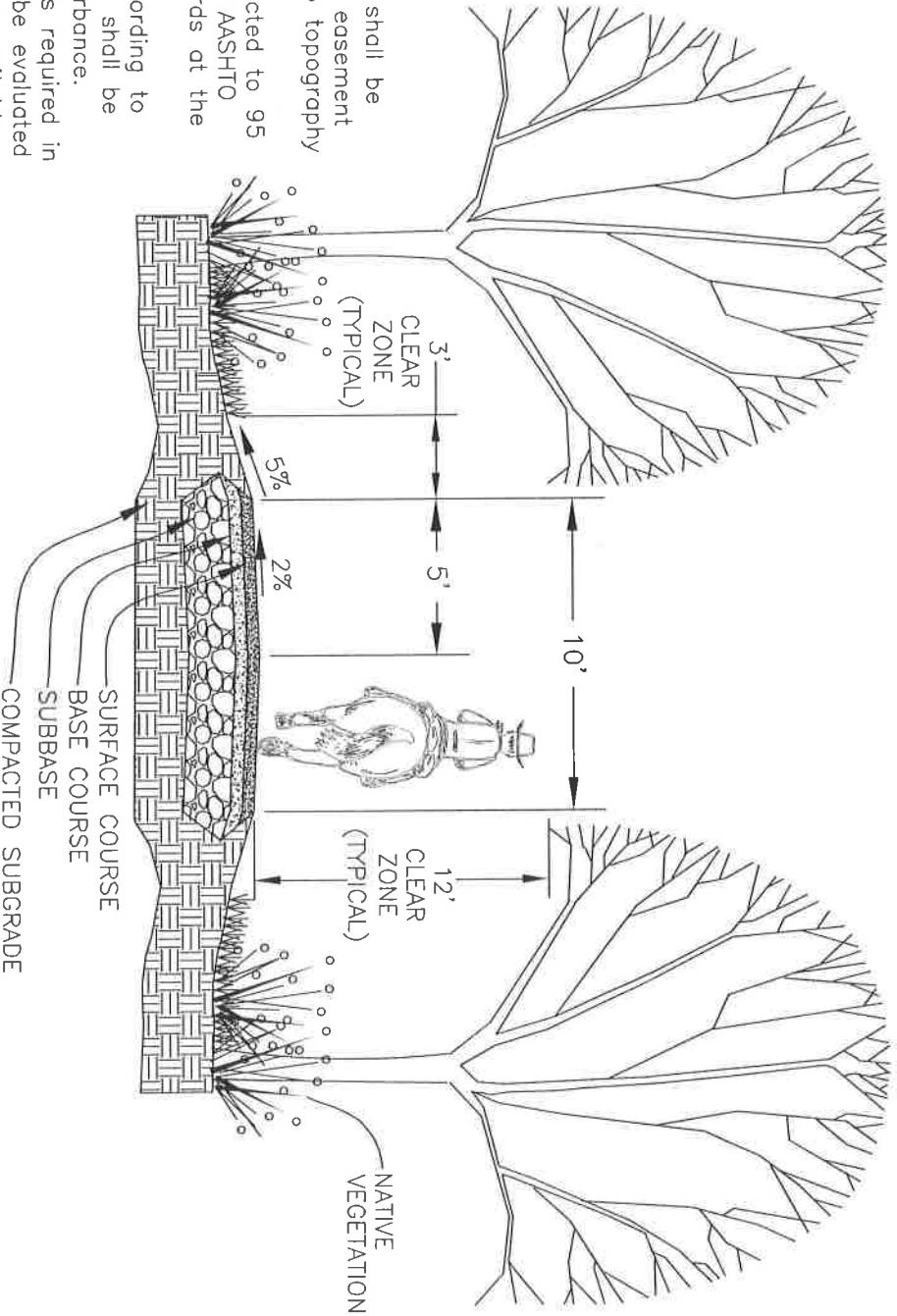

TYPE	TRAIL WIDTH (ft)	TRAIL CROSS SLOPE	SHOULDER WIDTH (ft)	SHOULDER CROSS SLOPE	SUBBASE AGG. BASE	BASE	SURFACE
NATURAL	10	2%	3	5%			
STONE DUST	10	2%	3	5%	See Note #4	2 in. 21-A Stone	2 in. Stone Dust or Blue Chip Stone

Detail No.

650.40

ET-1



COUNTY OF PRINCE WILLIAM VIRGINIA

EQUESTRIAN TRAIL (NOT ELIGIBLE FOR VDOT MAINTENANCE)

Date 7/15/14

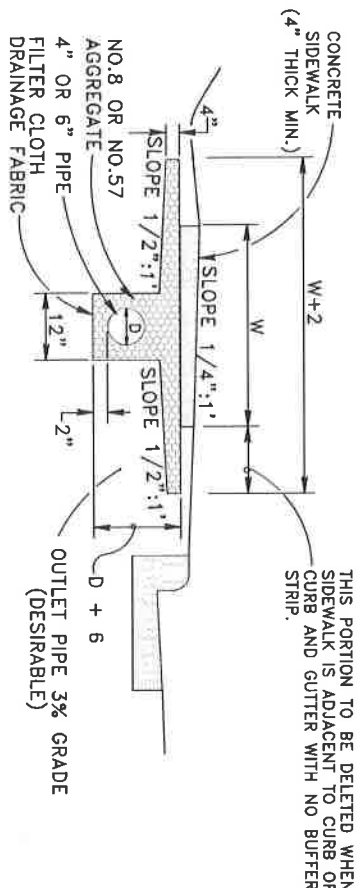

Type of Pipe	Crushing Strength LBS/FT	4in. I. D.	W.T.*	6in. I. D.
Vitrified Clay	1000		1000	
Concrete	1000		1100	
Corrugated Steel	1500		1500	
Corrugated Alum.	0.48		1400	
Asphalt Fiber	1200			1400
Small Wall PVC	103		0.153	
Smooth Wall PE**	ASSHTO M 252			ASSHTO M 252

* Wall Thickness (minimum) in inches
 ** Collared tubing allowed in four inch (4 in.) diameter only.

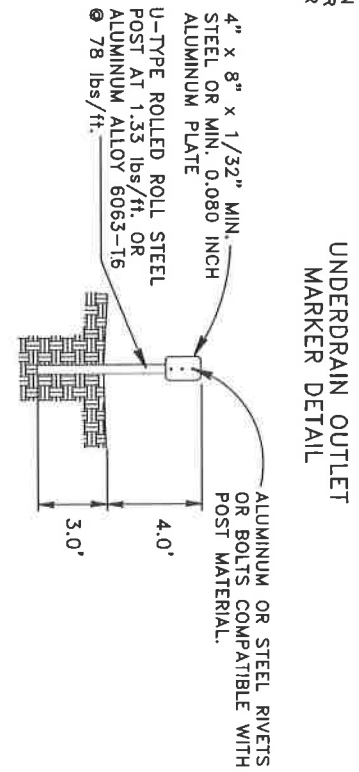

Type of Pipe	Crushing Strength LBS/FT	4in. I. D.	W.T.*	6in. I. D.
Vitrified Clay	1000		1000	
Concrete	1500		1500	
Corrugated Steel	0.52		1400	
Corrugated Alum.	0.48		1200	
Asphalt Fiber	1200			1400
Small Wall PVC	103		0.153	
Smooth Wall PE	70 PSI**			70 PSI **

* Wall Thickness (minimum) in inches
 ** Tested according to ASTM D 4212 at five percent deflection.

GENERAL NOTES:

- 1) Concrete sidewalk shall be Class A3 per VDOT specifications.
- 2) Sidewalk underdrain is to be used when the sidewalk longitudinal gradient is three percent (3%) or more and when the underlying soil has more than 34 percent passing the NO. 200 sieve and has a P1 of 13 or less.
- 3) Sidewalk underdrains should be tied into the storm sewer system at a point about one city block apart. Underdrain runs must not exceed 1,000 feet in length without discharging into the storm drain system or into an open drain.
- 4) All pipe to be six inches (6 in.) unless otherwise noted on plans.
- 5) Steel posts and plates to be painted or galvanized in accordance with the specification. If painted, the final coats shall be No. 13 aluminum paint or No. 11 white paint.
- 6) Marker to be placed at the outlet end of all underdrain installations barring locations where underdrain is tied into other drainage structures or as directed by the Department of Public Works.

Detail No.	SS-1	COUNTY OF PRINCE WILLIAM VIRGINIA
650.41		STANDARD SIDEWALK WITH UNDERDRAINS
		Date 7/15/14

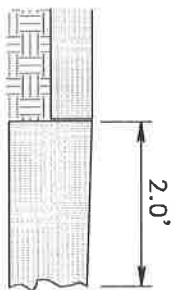
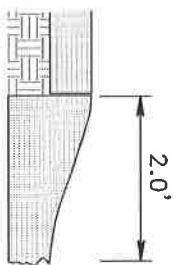
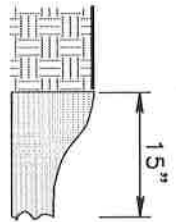
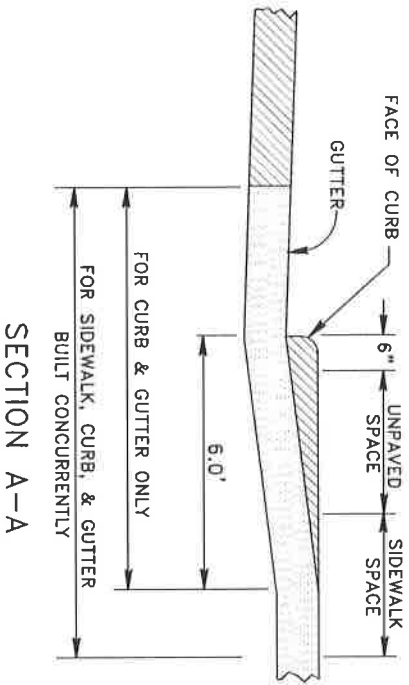
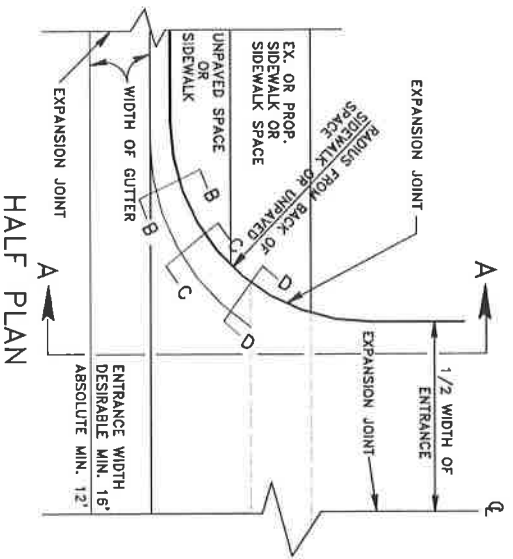

SECTION B-B SECTION C-C SECTION D-D
 WHEN USED IN CONJUNCTION WITH STANDARD CG-3, OR CG-7 THE CURB FACE ON THIS STANDARD IS TO BE ADJUSTED TO MATCH MOUNTABLE CURB CONFIGURATION

*NOTE: DESIGN SHALL CONFORM TO VDOT AND ADAAG REQUIREMENTS
 (1) REFER TO VDOT IIM LD-55 FOR DESIGN STANDARD NOTES FOR TRAVERSIBLE PATHS.
 (2) MINIMUM OF 2% AND MAXIMUM 3% CROSS SLOPES FOR ALL TRAVERSIBLE PATHS.

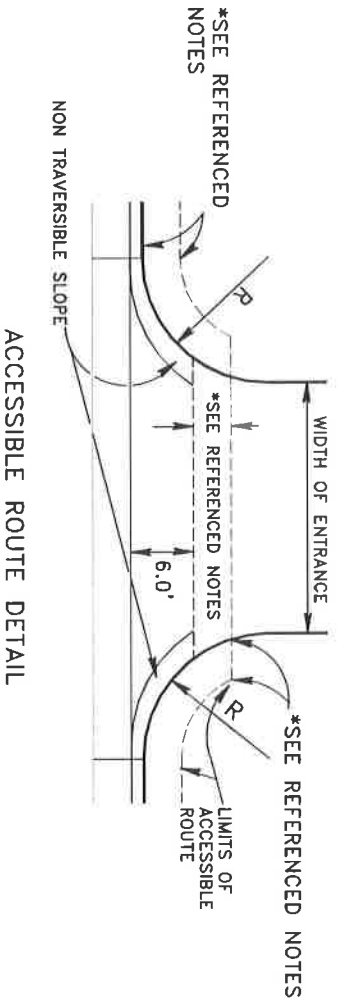

Detail No.

650.42

DE-1



COUNTY OF PRINCE WILLIAM VIRGINIA

ALTERNATIVE ENTRANCE WITH CURB AND GUTTER SHEET 1 OF 2

Date 7/15/14

GENERAL NOTES:

- 1) Detail to be used when the combined width of unpaved space and sidewalk spaces is less than seven feet (7 ft.).
- 2) Additional right-of-way is required if the limits of accessible route extends beyond existing or proposed VDOT right-of-way.
- 3) Accessible route is defined as a continuous unobstructed, stable, firm and slip resistant path connecting all accessible elements of a facility that can be approached, entered and used by persons with mobility impairments.
- 4) In situations such as extremely narrow lots, close spaced entrances, or if the lane adjacent to the curb will be used for parking at all times, CG-9A and 9B entrance gutters would be considered as last resort. This is per I & I Memorandum LD-94(D 208 of VDOT.
- 5) Six inches (6") of aggregate base material Type I, size 21B should be added beneath the Class A3 concrete.
- 6) Final pavement grades of driveways must be constructed on both ends flush, level, smooth and even with the garage approach and the driveway entrance aprons. The jointing of concrete and asphalt pavement and/or of concrete shall be done in a manner that will result in a smooth connection without a noticeable grade differential or lift. The grading must also provide positive drainage away from the garage.

Detail No.	DE-1	 <p>COUNTY OF PRINCE WILLIAM VIRGINIA</p>	<p>ALTERNATIVE ENTRANCE WITH CURB AND GUTTER SHEET 2 OF 2</p>	Date 7/15/14
650.42				

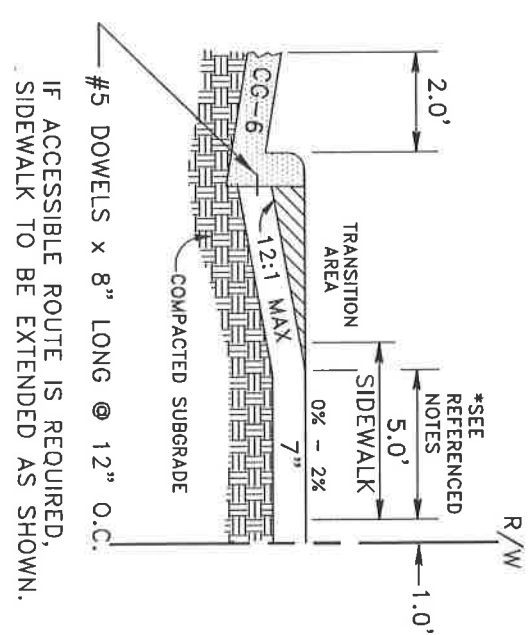
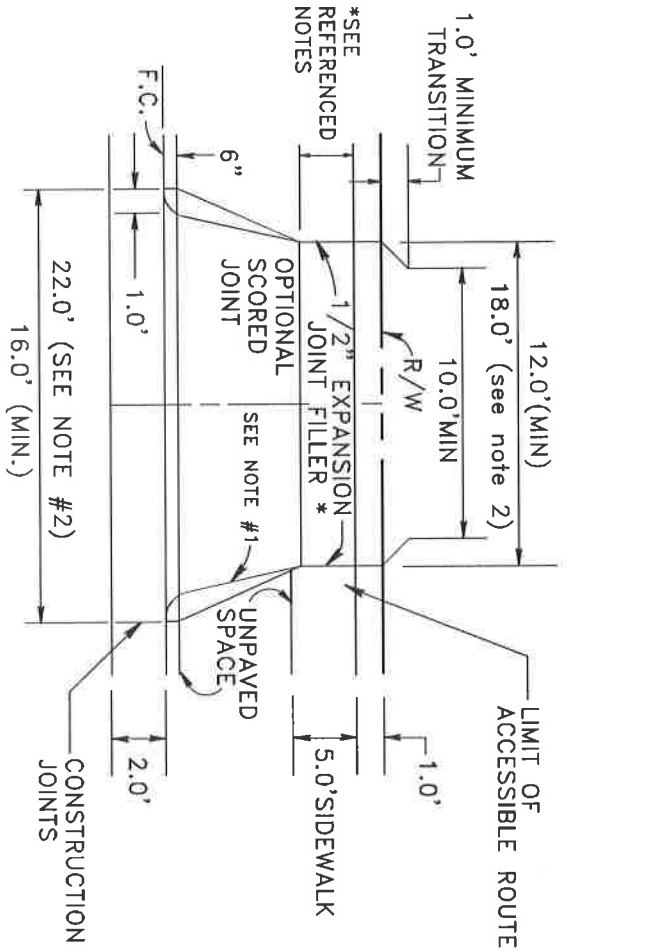

GENERAL NOTES:

- 1) For streets without sidewalk, the entrance apron may be constructed 2.5 feet beyond the back of the curb.
- 2) The driveway entrance widths shown are to be used on RPC, R-4C, R-4, R-2, and PMR zoning districts with double garage dwelling units and where the lot frontage is less than 70'. The driveway is to be aligned with the garage and the length or depth is less than 40 ft. measured from the right of way to the garage.
- 3) Slip forms will be allowed initially in the construction of CG-6.
- 4) Six inches (6") of aggregate base material type I, size 21B should be added beneath the class A3 concrete.
- 5) Final pavement grades of driveways must be constructed on both ends flush, level, smooth and even with the garage approach and the driveway entrance aprons. The jointing of concrete and asphalt pavement and/or of concrete shall be done in a manner that will result in a smooth connection without a noticeable grade differential or lift. The grading must also provide positive drainage away from the garage.
- 6) Design shall conform to VDOT and ADAAG requirements.

- *NOTES:**
- (1) REFER TO VDOT LIM LD-55.15 FOR DESIGN STANDARD NOTES FOR TRAVERSIBLE PATHS.
 - (2) MINIMUM OF 2% AND MAXIMUM 3% CROSS SLOPES FOR ALL TRAVERSIBLE PATHS.

IF ACCESSIBLE ROUTE IS REQUIRED, SIDEWALK TO BE EXTENDED AS SHOWN.

Detail No.

650.43

DE-2



COUNTY OF PRINCE WILLIAM VIRGINIA

DRIVEWAY ENTRANCE WITH CURB AND GUTTER (SINGLE FAMILY DETACHED)

Date 7/15/14

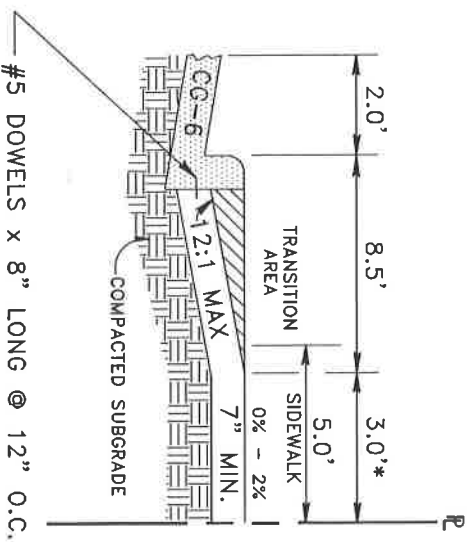
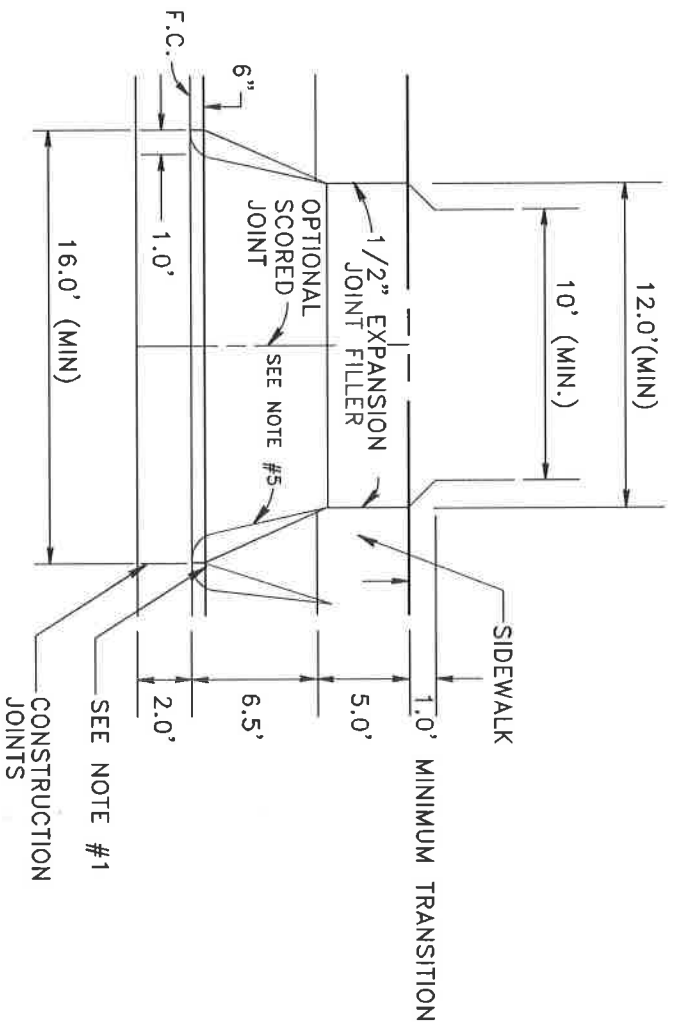

IF ACCESSIBLE ROUTE IS REQUIRED,
SIDEWALK TO BE EXTENDED AS SHOWN.
*A MINIMUM 3.0' TRAVERSIBLE
ACCESSIBLE ROUTE TO BE PROVIDED.

General Notes:

- 1) Depending on the layout of the units or the garage, the developer can modify the spacing or layout of the entrance apron provided that the minimum requirements are attained or achieved. Modifications will require the approval of the Director of Transportation.
- 2) Slip forms will be allowed initially in the construction of CG-6.
- 3) Six inches (6") of aggregate base material type I, size 21B should be added beneath the class A3 concrete.
- 4) Design shall conform to VDOT and ADAAG requirements.
- 5) For streets without sidewalk, the entrance apron may be constructed 2.5 feet beyond the back of the curb.

Detail No.	DE-3	COUNTY OF PRINCE WILLIAM VIRGINIA	TRAVELWAY DRIVEWAY ENTRANCE WITH CURB AND GUTTER (SINGLE FAMILY ATTACHED WITH GARAGE)	
650.44				Date 7/15/14

9" STONE SURFACE TO R/W LINE OR AS FAR AS GROUND IS DISTURBED WHICHEVER IS GREATER

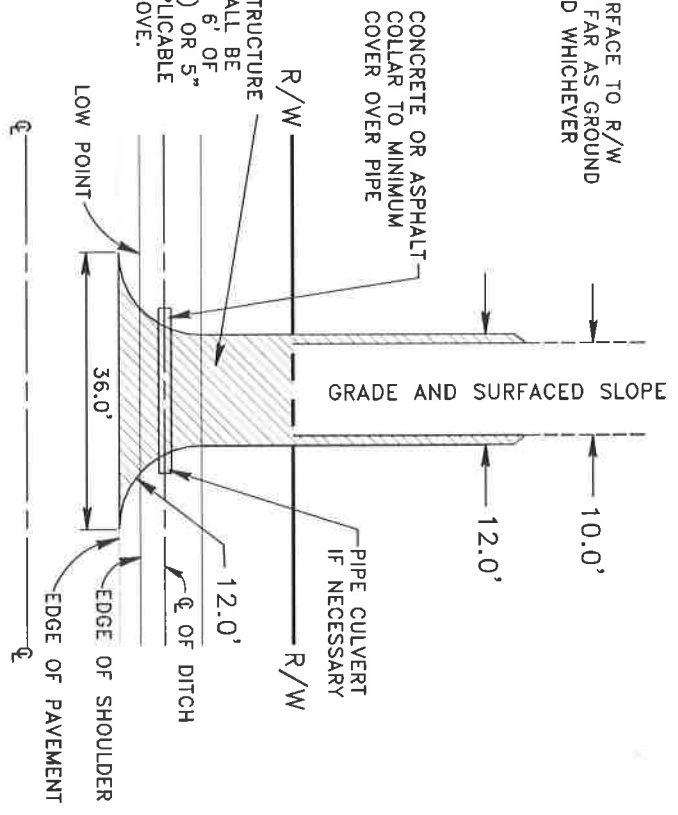

THE PAVEMENT STRUCTURE TO R/W LINE SHALL BE 2" SM-9.5A AND 6' OF AGGREGATE (MIN.) OR 5" CONCRETE IF APPLICABLE OR AS NOTED ABOVE.

WITH PAVED ROADSIDE DITCH

A paved ditch is required where soil conditions and runoff velocities will cause erosion.

2:1 slopes will be allowed where special stabilization is provided in accordance with erosion and sedimentation control ordinance.

NOTE: Design shall conform to County or VDOT requirements whichever is more stringent.

9" MIN. STONE COVER OVER PIPE OR MIN PAVEMENT DEPTH REQUIRED FOR THE ROAD.

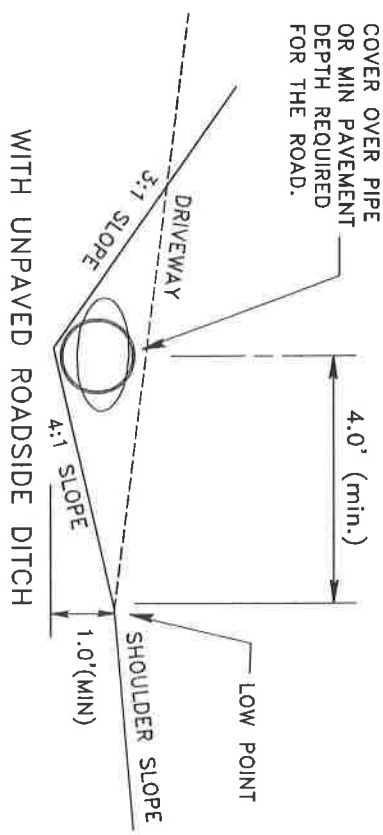

WITH UNPAVED ROADSIDE DITCH

9" MIN. STONE COVER OVER PIPE OR MIN. PAVEMENT DEPTH REQUIRED FOR THE ROAD.

WITH PAVED ROADSIDE DITCH

DRIVEWAY CULVERT PIPE INSTALLATION

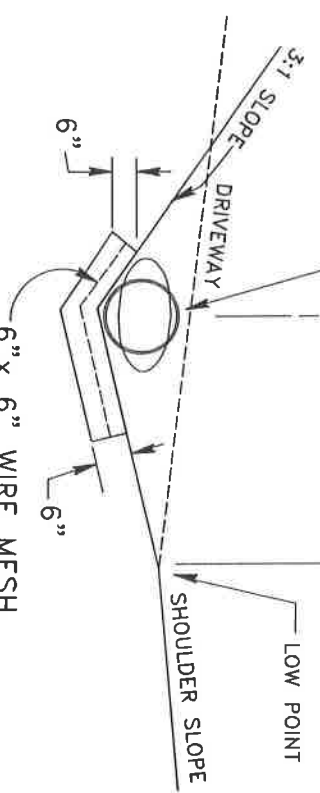

Detail No.

650.45

DE-4



COUNTY OF PRINCE WILLIAM VIRGINIA

DRIVEWAY ENTRANCE WITH DITCH SECTION SHEET 1 OF 2

Date 7/15/14

GENERAL NOTES:

- 1) All construction methods and materials shall conform to current VDOT standards
- 2) Concrete pipe or corrugated metal pipe may be used. The type and size shall be indicated on the plans.
- 3) Driveways shall be surfaced from edge of pavement to property line with the same type of surfacing used on the street.
- 4) All driveway grades shall slant back of the shoulder line.
- 5) In cut sections, the sides of the driveway shall be graded to a maximum 3:1 slope.
- 6) Lengths of culverts shall be a minimum of twenty feet (20 ft.), if not shown on plans.
- 7) For dimension of S, see Standard RL - 1, and RM - 1.
- 8) Ditch line may be moved back to provide required cover. The transition of the ditch line should be smooth with a minimum length of ten feet (10 ft.).
- 9) This detail shall only be used for entrances on local streets with projected traffic counts not exceeding 1000 vpd. Driveway entrance PE-1 of VDOT Road and Bridge Standard Manual shall be used on streets with projected traffic counts exceeding 1000 vpd but not more than 4000 vpd.
- 10) This driveway entrance shall be required on rural residential developments with ditch section paved roadways and where the minimum lot size is one (1) acre or more. Paving of driveway entrance shall be per Detail 650.01 of the DCSM and as shown.

DRIVEWAY CLEARANCES:

- 1) Grading plans must provide for adequate vehicular clearance for driveway approach, departure and breakover transitions. Driveway profiles are required where steep grades prevail. Driveways shall be graded to ensure positive drainage away from the house.
- 2) Final pavement grades of driveways must be constructed on both ends flush, level, smooth and even with the garage approach and the driveway entrance aprons. The jointing of concrete and asphalt pavement and/or of concrete shall be done in a manner that will result in a smooth connection without a noticeable grade differential or lift. The grading must also provide positive drainage away from the garage.

Detail No.	DE-4		COUNTY OF PRINCE WILLIAM VIRGINIA	DRIVEWAY ENTRANCE WITH DITCH SECTION SHEET 2 OF 2	Date
650.45					7/15/14

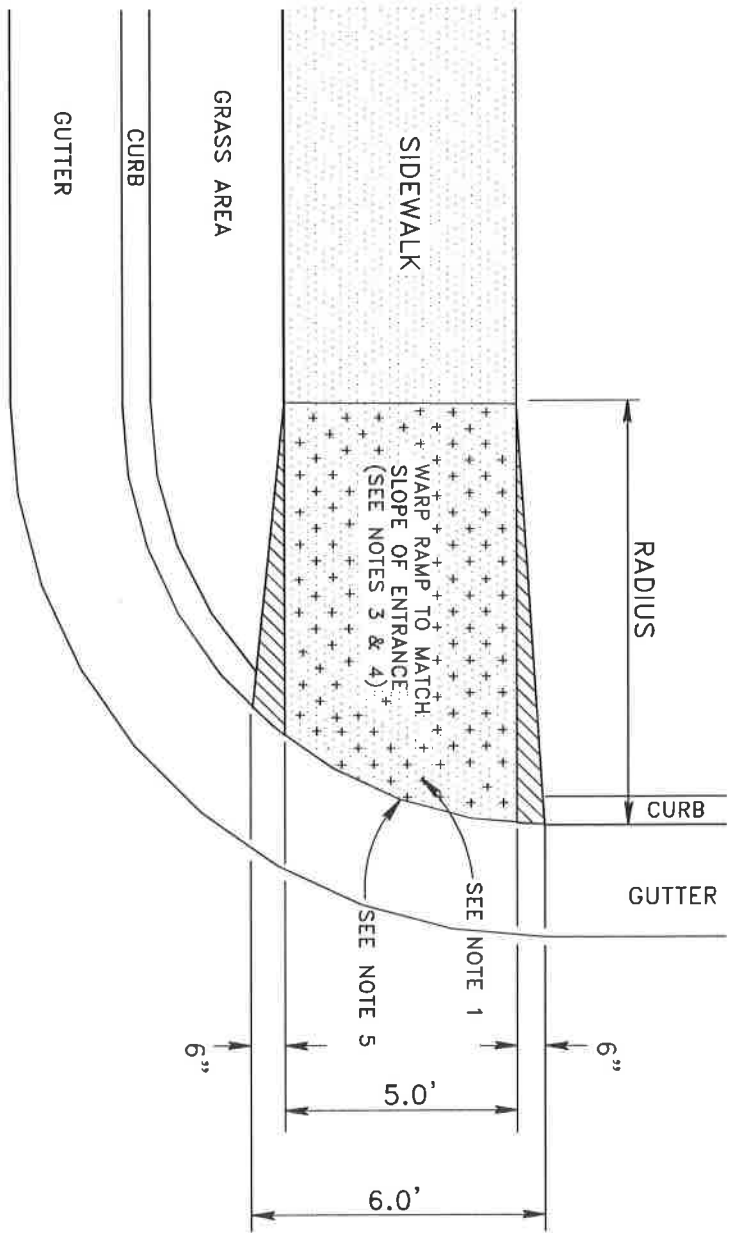

GENERAL NOTES:

- 1) All handicapped ramps and hazardous vehicle ways shall be provided with detectable warning surfaces conforming to and in accordance with the latest VDOT curb ramp standards.
- 2) Ramps are to be located as shown on the plan or accessible routes as determined by the standards.
- 3) The maximum slope shall not exceed 12:1 under any circumstance.
- 4) The design shall be in accordance with the minimum latest requirements and guidelines of the Virginia Uniform Statewide Building Code Section 512 (accessibility for disabled) and VDOT IIM-LD-55.10.
- 5) The maximum lift shall be one-half inch (1/2 in.), otherwise they shall be eliminated.

Detail No.	CCR-1		COUNTY OF PRINCE WILLIAM VIRGINIA	CURB CUT RAMP	Date
650.46					7/15/14

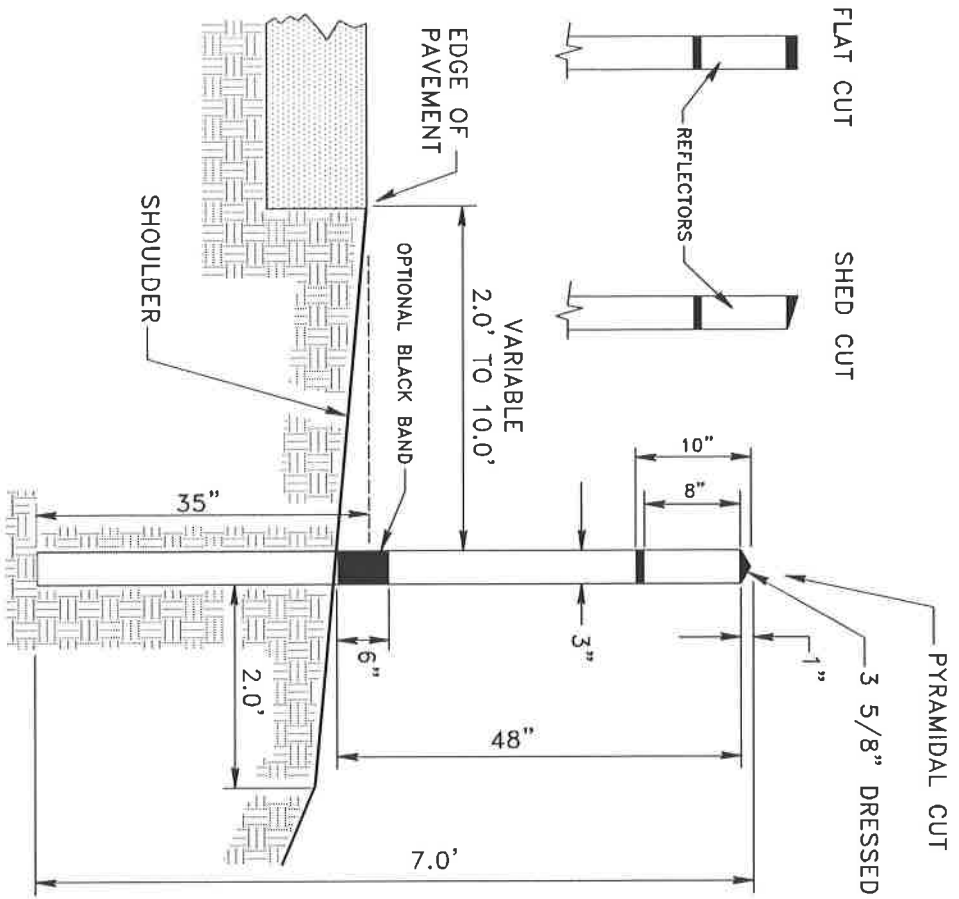

General Notes:

- 1) Standard ED-1 delineators consist of reflectorized sheeting, cut to a 3 in. x 8 in. vertical rectangle, mounted on a backing of aluminum alloy, not less than 0.063 inches thick conforming to ASTM B209, alloy 6061-T6 or 5052-H38. The color of the reflective sheeting shall in all cases conform to the color of the edgelines.
- 2) The reflectors are attached to wood posts with a minimum of two (2) aluminum nails or screws produced from alloy 2024-T4 or 6061-T6.
- 3) The posts above the ground are painted white with paint No. 11.
- 4) Posts are treated with a water-borne preservative in accordance with section 236 of the VDOT Road and Bridge Specifications.
- 5) The top of the posts may have a flat, shed, or pyramidal cut; however they shall be uniform throughout the project in accordance with Standard WSP-1.
- 6) All construction methods and materials shall conform to the current VDOT standards.

Detail No.	ED-1	 COUNTY OF PRINCE WILLIAM VIRGINIA	STANDARD ROAD EDGE DELINEATORS	
650.47				Date 7/15/14

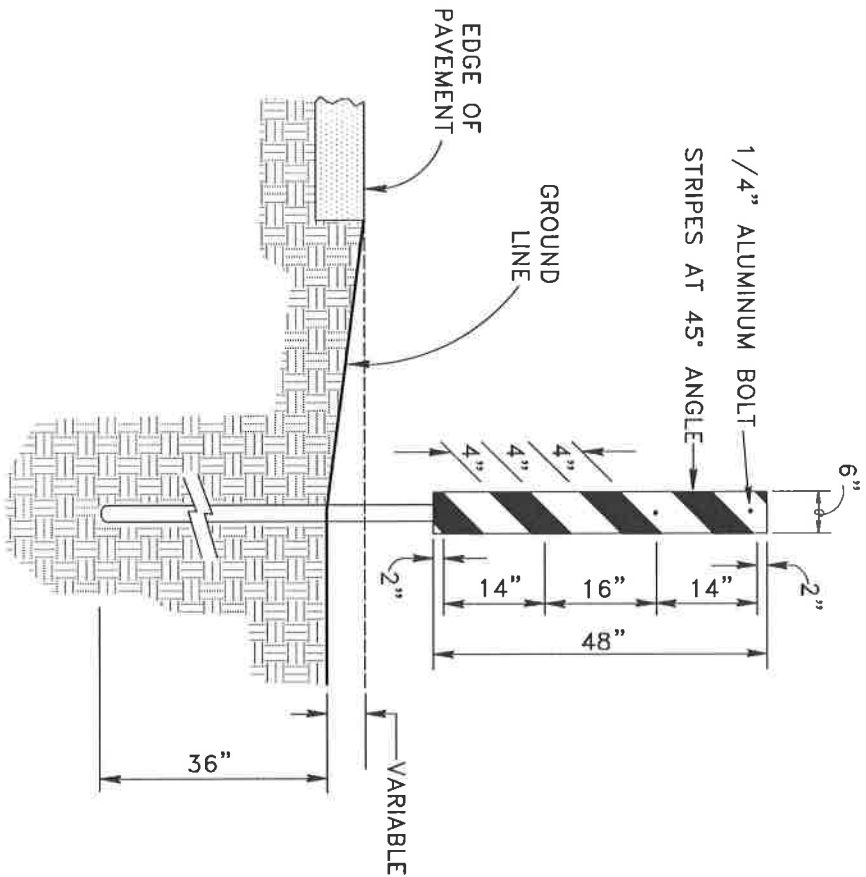

General Notes:

- 1) Special delineators are made from aluminum alloy not less than 0.080 inches thick conforming to ASTM B209, alloy 6061-T6 or 5052-h38.
- 2) All delineator are reflectorized and in all cases the color shall conform to the color of the edgelines alternating with a black stripe.
- 3) Stripes shall slope downward toward the center of the roadway.
- 4) The delineator panel extends one inch (1 in.) above the top of the post.
- 5) The bottom of the delineator panel is twelve inches above the edge of pavement elevation.
- 6) Delineators are mounted on u type posts fabricated from rolled steel 1.33 lb./lf. minimum.
- 7) All construction methods and materials shall conform to the current VDOT Road and Bridge Standards.

Detail No.			COUNTY OF PRINCE WILLIAM VIRGINIA	SPECIAL ROAD EDGE DELINEATORS	Date 7/15/14
650.48					

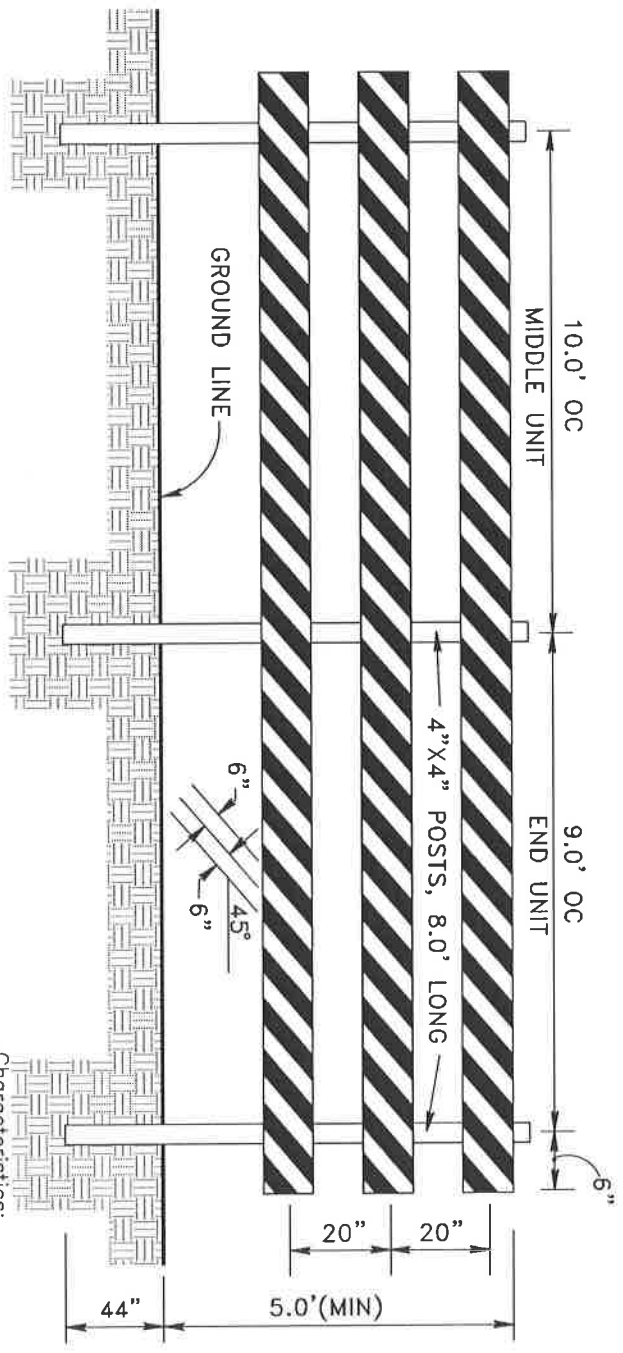

GENERAL NOTES:

- 1) Barricades shall be used at the end of pavement on all dead end streets.
- 2) Posts and planks shall be in accordance with Section 236.02 (c) of VDOT's Road and Bridge Specifications.
- 3) Planks shall be painted completely white. Posts shall be painted white on all sides to within six inches (6 in.) of the ground level.
- 4) Good quality oil base exterior grade paint must be used. Six inch (6 in.) high intensity reflective orange and white stripe tape on one side for the full length of the barricade.
- 5) Each plank shall be secured to each post with (2)-3/8 in x 6-1/2 in. carriage bolts or with (2) 7/16 in. x 4 in. lag screws with washers. Bolts or screws are to be placed two inches (2 in.) from edge of planks.
- 6) Where necessary for safety of pedestrian traffic, a full extension of the barricade may be required to the limits of the right of way.
- 7) Where provision must be made for access of equipment and authorized vehicles, lockable gates may be provided in one section of the barricade.

Characteristics:
 Color of stripes—Reflective orange and white
 Width of roll — 8" min. to — 12" max.
 Number of reflectorized roll faces:
 —3 if facing traffic in one direction
 —6 if facing traffic in two directions

Detail No.	TB-1	 COUNTY OF PRINCE WILLIAM VIRGINIA	STANDARD TYPE III TRAFFIC BARRICADE
650.49			
			Date 7/15/14

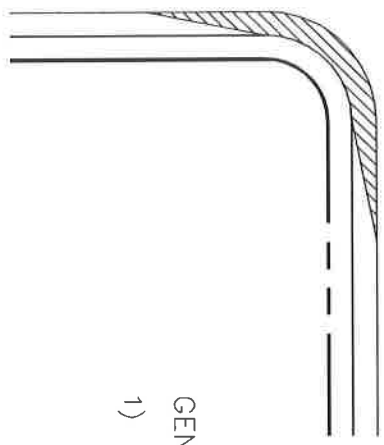
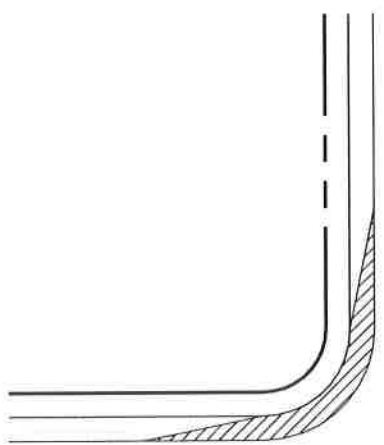
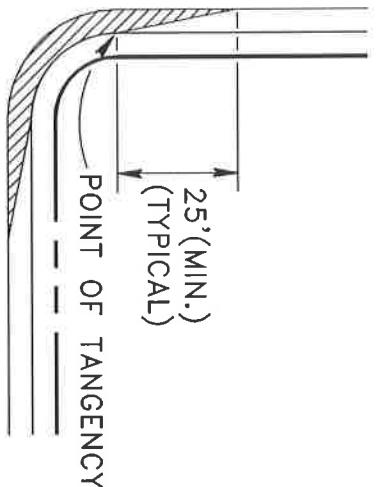
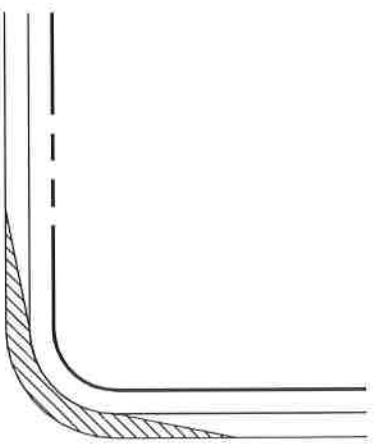

GENERAL NOTES:

- 1) The pavement structure of the mainline roadway pavement shall be extended one foot (1 ft.) at the same slope into the shoulder. The remainder of the shoulder areas requiring stabilization shall be paved with one and one-half inch (1-1/2 in.) SM-9.5A.
- 2) Minimum intersection turning radius shall be fifty feet (50').

Detail No.	SI-1		COUNTY OF PRINCE WILLIAM VIRGINIA	SHOULDER STABILIZATION AT INTERSECTIONS	Date
650.50					7/15/14

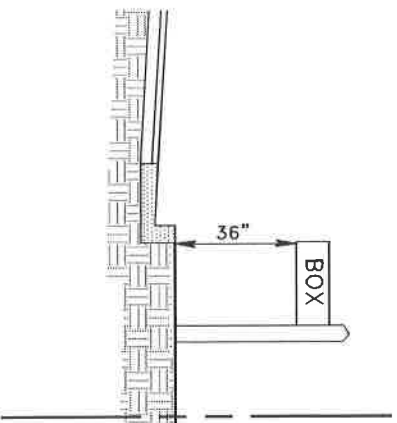

CURB AND GUTTER SECTION

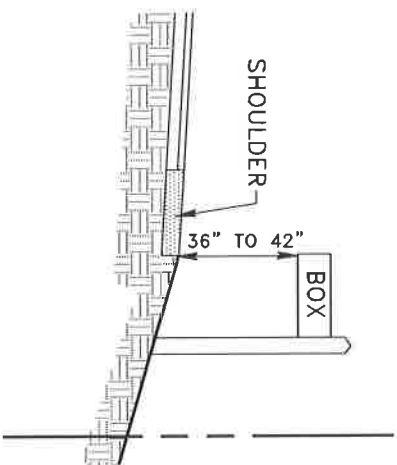

FILL SECTION

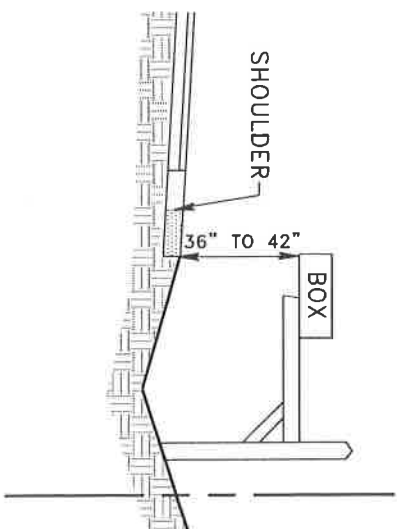

CUT SECTION

DITCH SECTION STREET

GENERAL NOTES:

- 1) On ditch section streets, the face of the mail box shall be in line with the back edge of the shoulder.
- 2) On ditch section streets in a cut section, the support for the mail box shall be a minimum of two feet (2 ft.) from the outside of the ditch line.
- 3) On curb and gutter section streets, the face of the mail box shall be in line with the back edge of the curb line.
- 4) The face of the mail box and post shall be set, as shown on line fill section detail, with-in the radius of the entrance.
- 5) The mail box height shall be:
 - a) On a ditch section, 36 inches to 42 inches from the shoulder grade to bottom of box.
 - b) On a curb and gutter section, 36 inches from the top of curb to the bottom of box.

Detail No.	 COUNTY OF PRINCE WILLIAM VIRGINIA		MAILBOX LOCATION	
650.51				MBL-1
				Date 7/15/14

FHWA, SERIES "B" WHITE HIGH INTENSITY LETTERS (USE UPPER AND LOWER CASE LETTERS)

YEAR SIGN INSTALLED OR REPLACED

2 3/8" OUTSIDE DIAMETER GALVANIZED STEEL POST

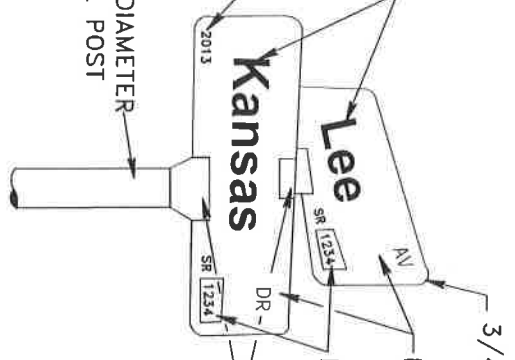

3/4" RADIUS, DIE CUT, ALL CORNERS

BACKGROUND TO BE GREEN HIGH INTENSITY

ROUTE # DECAL

CAST ALUMINUM ALLOY (ASTM B26-356-T6) BRACKET AND POST CAP WITH 5/16" CADMIUM PLATED, ALLEN HEAD, KNURLED SET SCREWS CAST OR MACHINED FOR 0.080 THICK BLANKS SET SCREWS TO BE ON OPPOSITE SIDES OF SLOTS.

1. POST MAY BE SET IN TAMPED EARTH OR CONCRETE CLASS A3 IN ACCORDANCE WITH VDOT'S STP-1 DETAIL.
2. BREAK-AWAY POSTS ARE OPTIONAL.

Detail No.	650.52	SNS-1		COUNTY OF PRINCE WILLIAM VIRGINIA		STREET NAME SIGN STANDARD SHEET 1 OF 2		Date 7/15/14	
------------	--------	-------	--	-----------------------------------	--	--	--	-----------------	--

GENERAL NOTES:

1. Street name signs shall conform to the standards in the table below for sizes as follows:

- Size A: Subdivision streets
- Size B: Arterials, parkways and collector streets

Shape Horizontal Rectangle

Color

Message: White (Reflectorized)
Field: Green (Reflectorized)

Size *

Street Name Sign

	Size A	Size B
Horizontal	24 in. min.	30 in. min.
Horizontal	48 in. max.	48 in. max.
Vertical	6 in. min.	9 in. min.

Route Decal

Horizontal (Field)	4 in.	6 in.
Vertical	1.25 in.	2.50 in.

Message

* Street Name Sign – Use Upper and Lower Case Letters

Street Name	4 in. C	6 in. C
Suffix Capitals	3 in. C	4 in. C

Route Decal

Capitals/Numerals	1 in. C	2 in. C
-------------------	---------	---------

* Dimensions may be modified as approved by the Director of Transportation.

Detail No.	SNS-1		COUNTY OF PRINCE WILLIAM VIRGINIA	STREET NAME SIGN STANDARD SHEET 2 OF 2	Date 7/15/14
650.52					

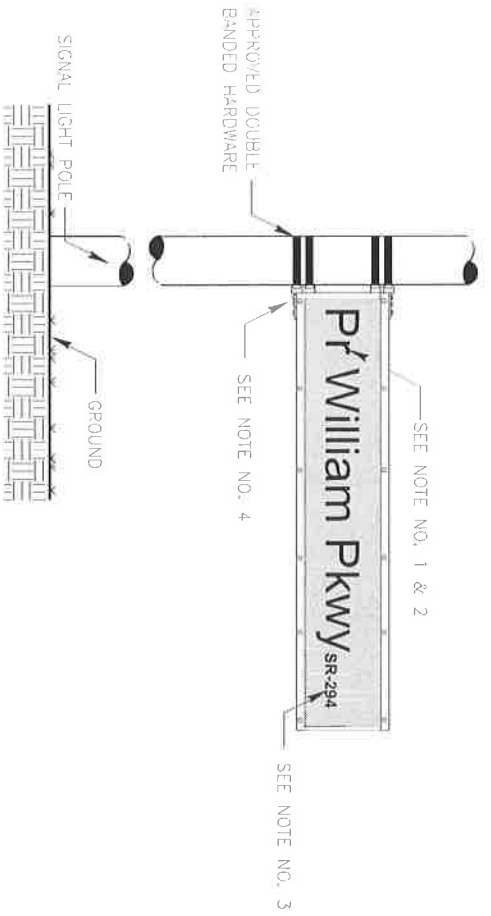

SIGNAL POLE MOUNTED

GENERAL NOTES:

- 1) Standard sign panel should be .10 gauge (VDOT standard), and have dimensions of 1'X6'. Material shall be high intensity. Color shall be white on blue with 0.5" border.
- 2) Letter dimensions should be 8" E modified upper case letters with 6" E lower case letters in clearview font.
- 3) State Route numbers on bottom right of the sign panel should be 2" uppercase letters and numbers.
- 4) Use VDOT approved hardware only.
- 5) Signs should be 2 sided.
- 6) Street name sign placement on both most arm and span wire intersections should be placed on the vertical pole to the right of the signal heads. These signs should be installed level with the bottom of the traffic signal heads as long as they do not interfere with any signal equipment. (Recommend 17")

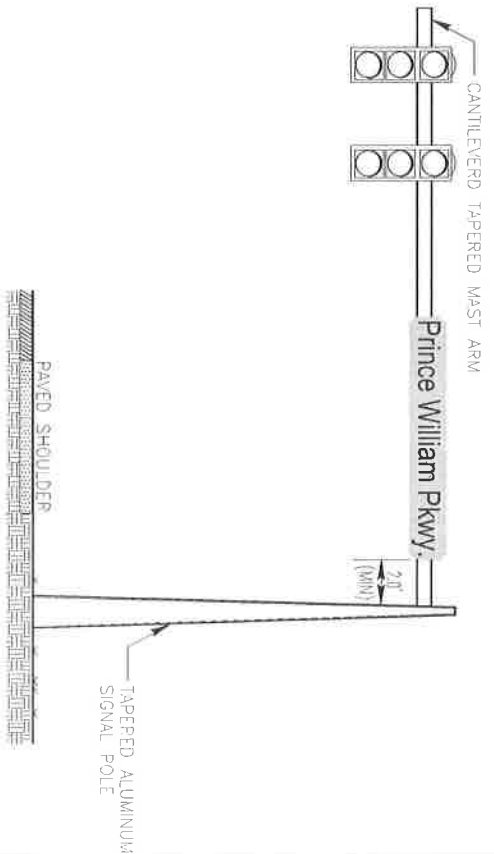

MAST ARM MOUNTED

GENERAL NOTES:

- 1) All text should be in clearview font only.
- 2) Color should be white on blue with 0.5" border and 2" corner radius.
- 3) Please see VDOT specifications for sign mounting hardware.

Detail No.:	SNS-2			COUNTY OF PRINCE WILLIAM VIRGINIA	STREET NAME SIGNS ON TAPERED ALUMINUM SIGNAL POLES	Date 7/15/14
650.53						

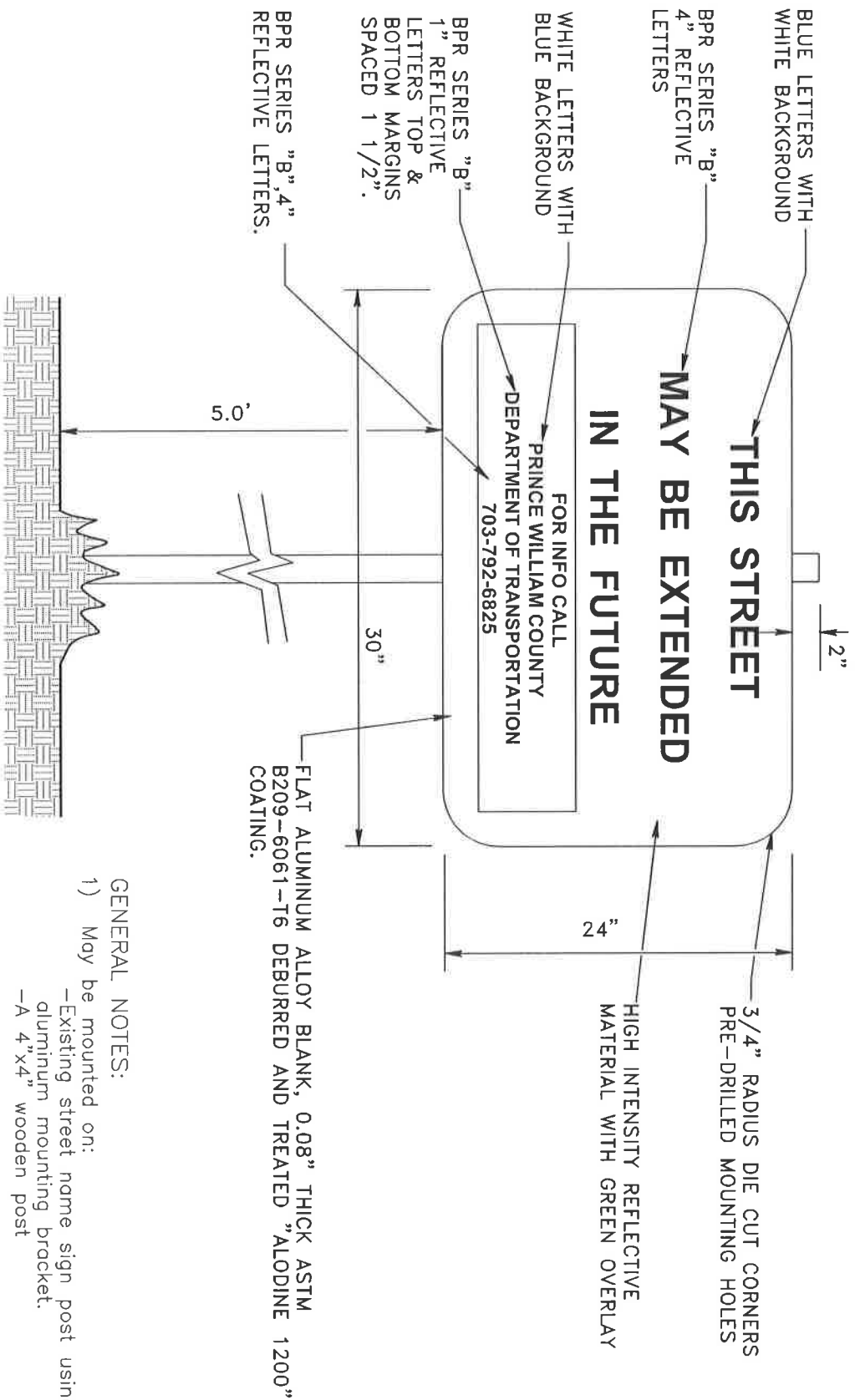

GENERAL NOTES:
 1) May be mounted on:
 -Existing street name sign post using aluminum mounting bracket.
 -A 4"x4" wooden post

Detail No.	TSS-1		COUNTY OF PRINCE WILLIAM VIRGINIA	THRU STREET SIGN STANDARD	Date
650.54					7/15/14



W14-1P
36" x 12"



W14-2P
36" x 12"



W14-1
30" x 30"



W14-2
30" x 30"

GENERAL NOTES:

- 1) Refer to the current VDOT Road and Bridge Standard STP-1, Square Tube Sign Post for post specifications and installation.
- 2) Post may be set in tamped earth or concrete class A3 in accordance with VDOT's STP-1 detail.
- 3) The lowest portion of the signs shall be a minimum of seven (7) feet above the curb and gutter and five (5) feet above the crown on ditch section streets.
- 4) If plaques (W14-1P, 2P) are used in combination with the stop signs or the route markers, their placement shall be per Note 3 above.
- 5) Placement, sizes, and material specifications shall be in accordance with the requirements of the Manual on Uniform Traffic Control Devices (MUTCD) unless otherwise directed by VDOT.

Detail No.	COUNTY OF		DEAD END/NO OUTLET STREET SIGN STANDARD	Date
650.55	DES-1	PRINCE WILLIAM VIRGINIA		7/15/14

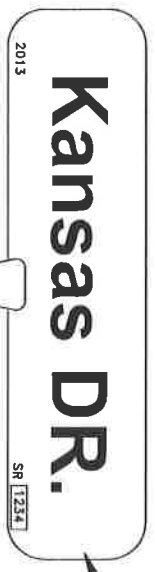

EXISTING STREET NAME SIGN
(FOR PIPESTEM DRIVEWAY ADDRESS)
RANGE WILL REPLACE EXISTING
STREET NAME SIGN)

HIGH INTENSITY REFLECTIVE
MATERIAL WITH GREEN
OVERLAY

BPR. SERIES "B" WHITE
2" REFLECTIVE LETTERS
TOP AND BOTTOM MARGINS
SPACED 1 1/2".

FLAT ALUMINUM ALLOY BLANK
0.08 in. THICK
ASTM B209-6061-T6,
REBURRED AND TREATED
"ALODINE 1200" COATING

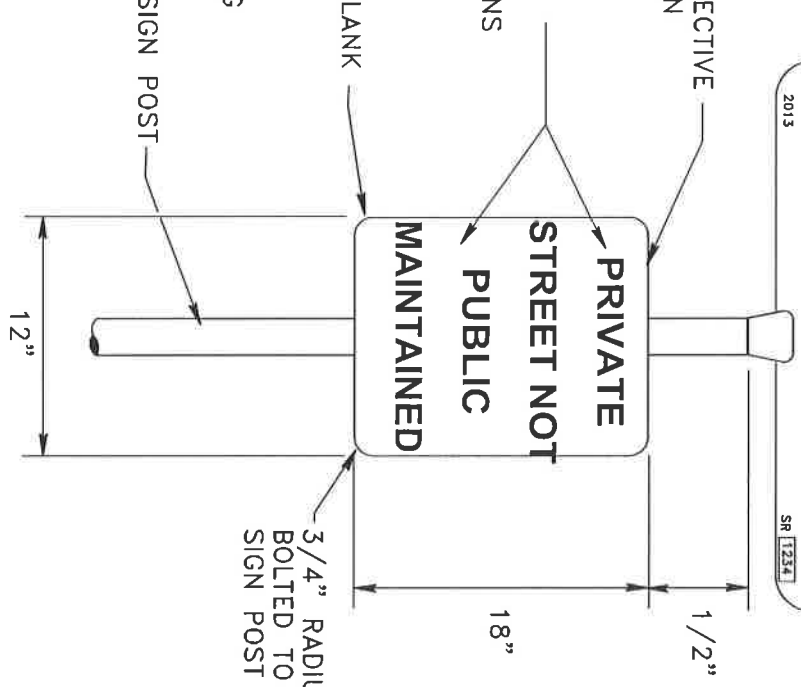

SEE DETAIL 650.52 FOR STREET
NAME SIGN AND DETAIL 650.60 FOR
ADDRESS RANGE SIGN

3/4" RADIUS DIE CUT, ALL CORNERS
BOLTED TO EXISTING STREET NAME
SIGN POST

- GENERAL NOTES:
1. The sign is to be mounted with aluminum alloy brackets which clamp to sign post 1 1/2" from top.
 2. Break-away posts are optional.

Detail No.	PSS-1		COUNTY OF PRINCE WILLIAM VIRGINIA	PRIVATE STREET SIGN STANDARD	Date
650.56					7/15/14

SIGN SHALL BE LOCATED SUCH THAT IT WILL NOT BE OBSCURED BY VEHICLE PARKED IN SPACE.

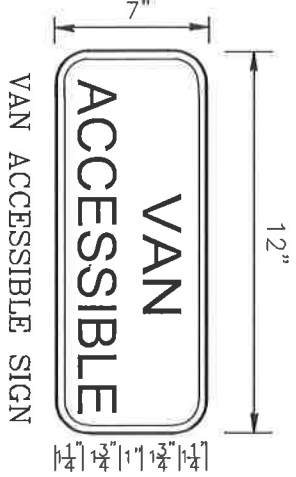
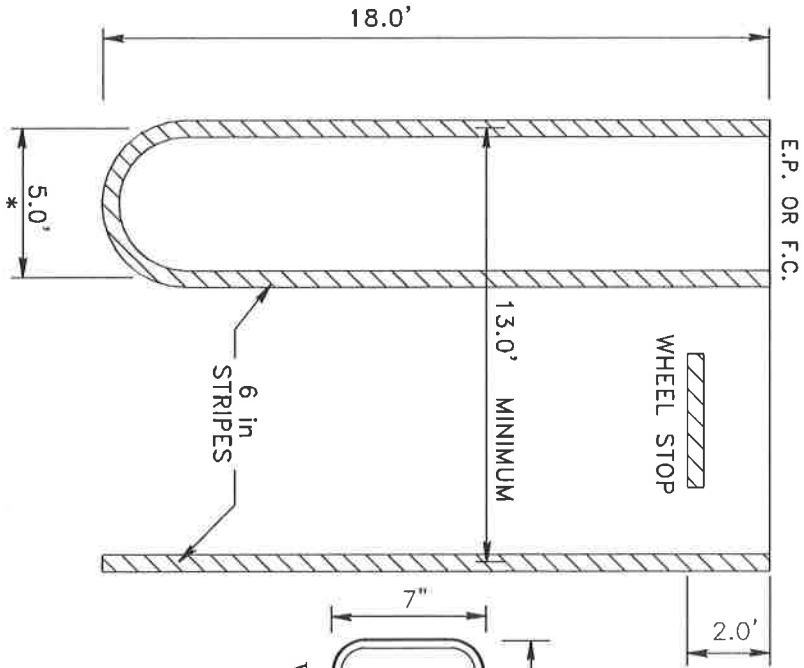

LIGHT COLORED REFLECTIVE BACKGROUND MAT'L
DARK COLORED 2" LETTERS & 3/8" BORDER

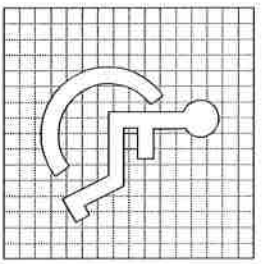

INTERNATIONAL SYMBOL OF ACCESSIBILITY



DISPLAY CONDITIONS

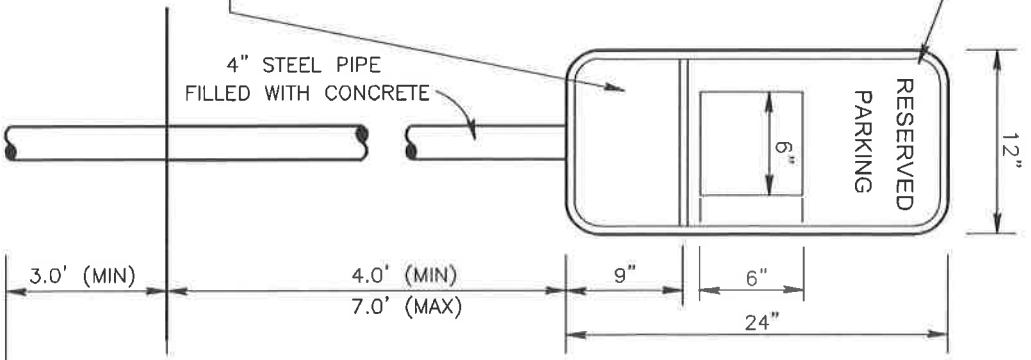
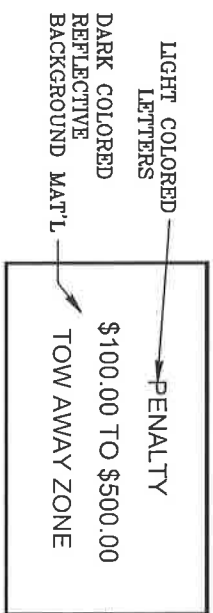

General Notes:
 * When the space provided is van accessible, dimension shall be 8.0' in accordance with VUSBC minimum requirements.

- 1) Access ramp must be located at some point adjacent to the eight foot (8 ft.) aisle.
- 2) Slopes on parking spaces and accessible aisle shall not exceed two percent 2% in all directions.
- 3) Van accessible signs shall also be provided where required.

Detail No.	650.57	HP-1		COUNTY OF PRINCE WILLIAM VIRGINIA	ACCESSIBLE PARKING SPACE STANDARD	Date 7/15/14
------------	--------	------	--	-----------------------------------	-----------------------------------	-----------------

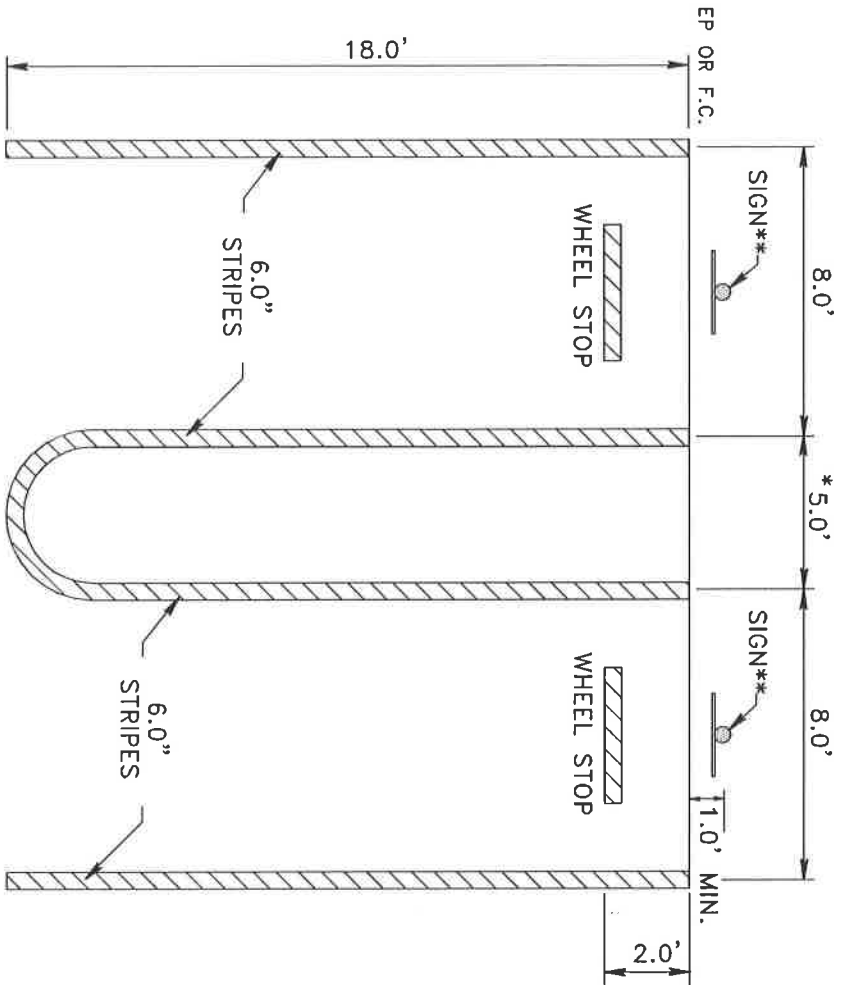

* Where the space provided is van accessible, dimensions shall be eight feet (8 ft.) in accordance with VUSBC minimum requirements. When accessible parking spaces are used for emergency access, they shall be located as close as possible to the entrance of the building.

** Refer to HP-1 (Std. 650.57) for sign detail and location.

GENERAL NOTES:

- 1) Access ramp must be located adjacent to the five foot (5 ft.) aisle.
- 2) Slopes on the parking spaces and accessible aisles shall not exceed two percent (2%) in all directions.

Detail No.	HP-2		COUNTY OF PRINCE WILLIAM VIRGINIA	ACCESSIBLE PARKING SPACE STANDARD FOR TWO ADJACENT PARKING SPACES	Date
650.58					7/15/14

ELEVATION VIEW

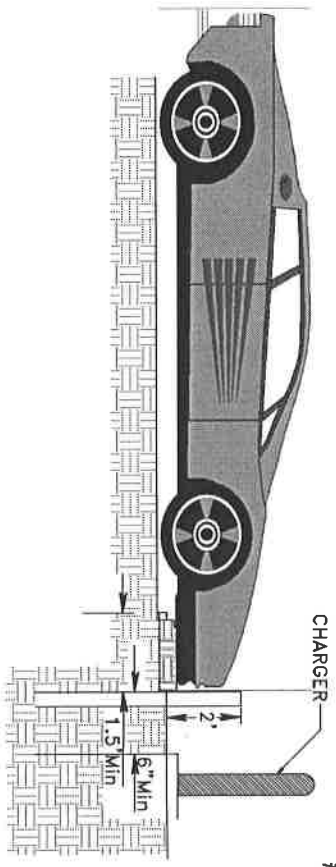

Conduit per manufacturer's specs
#4 bars all



PLAN VIEW

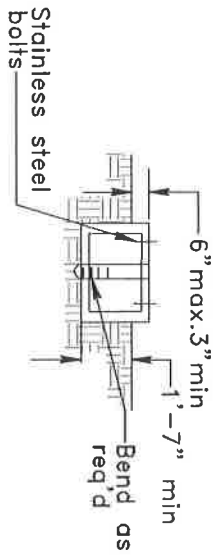

ELEVATION VIEW
RECTANGULAR CHARGER FOUNDATION

Conduit per manufacturer's specs



PLAN VIEW

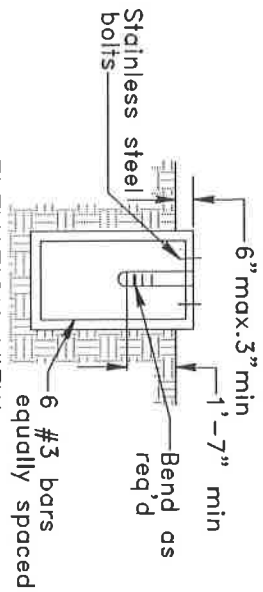

ELEVATION VIEW
CIRCULAR CHARGER FOUNDATION

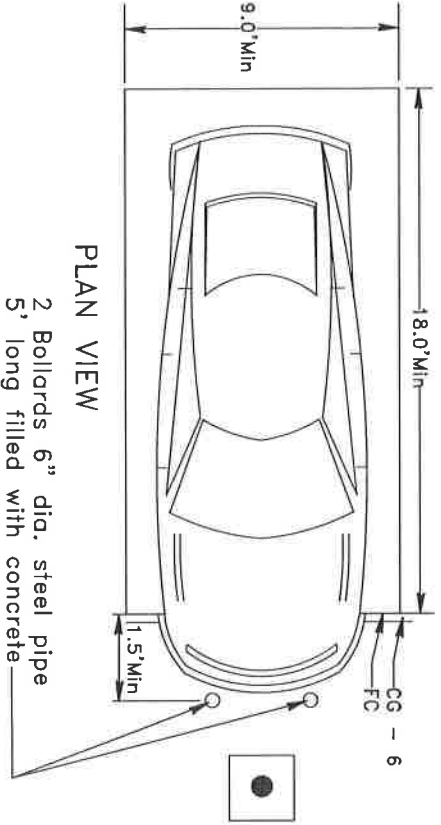

PLAN VIEW

2 Bollards 6" dia. steel pipe
5' long filled with concrete

Notes:

1. 28 day strength of concrete shall be 3,000 psi min.
2. Reinforcing steel shall conform to ASTM AG-15-89 (SI), grade 40.
3. Refer to charger manufacturer's specifications.

Detail No.

650.59

EV-1



COUNTY OF
PRINCE WILLIAM
VIRGINIA

ELECTRIC VEHICLE (EV)
CHARGING STATION

Date
7/15/14

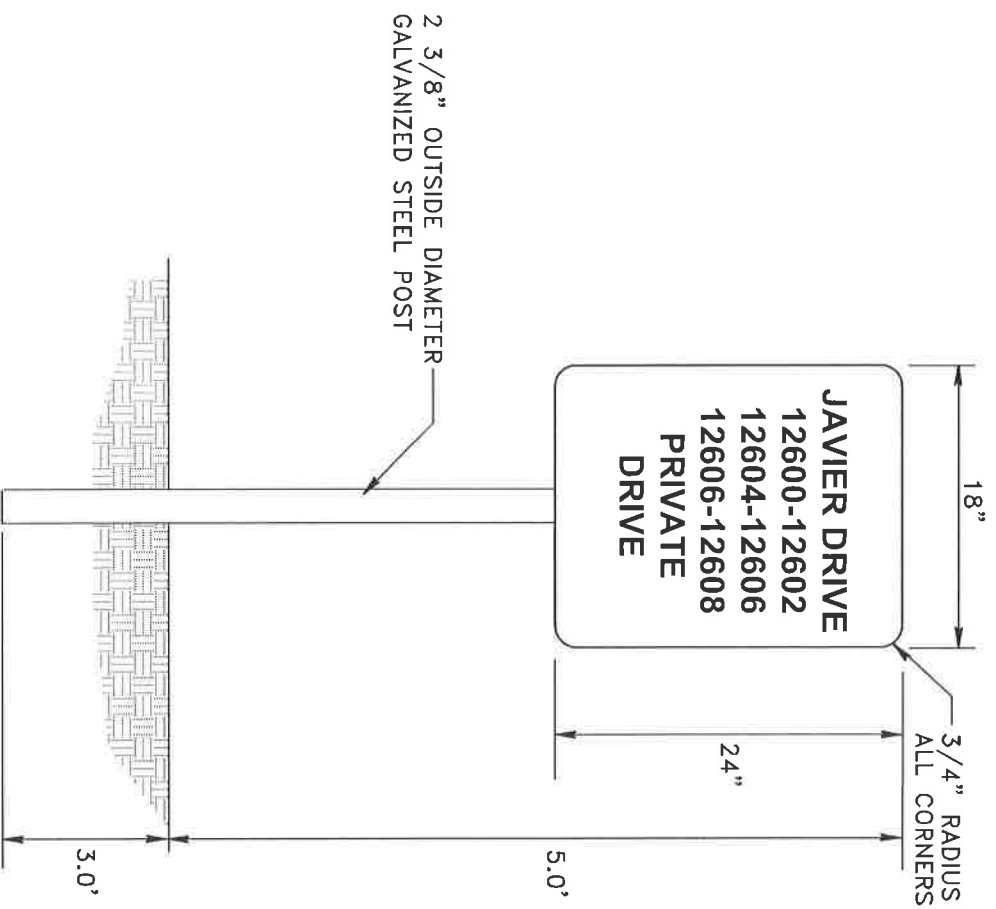

- General Notes:
- 1) The sign shall be placed on right side of the pipestem driveway and outside of the sight distance easement.
 - 2) The sign shall include the street name of the pipestem driveway, house numbers and the words "Private Street" or "Private Drive."
 - 3) The lettering on the sign should be 2" in height. The background shall be made of green reflective materials.
 - 4) Alternate design will require pre-approval from the Director of Transportation.
 - 5) The sign shall be located outside the existing or proposed roadway right of way.
 - 6) Break-away posts are optional.

Detail No.	ARS-1		COUNTY OF PRINCE WILLIAM VIRGINIA	ADDRESS RANGE SIGN FOR PIPESTEMS	Date
650.60					7/15/14

COBRA TYPE STREETLIGHT

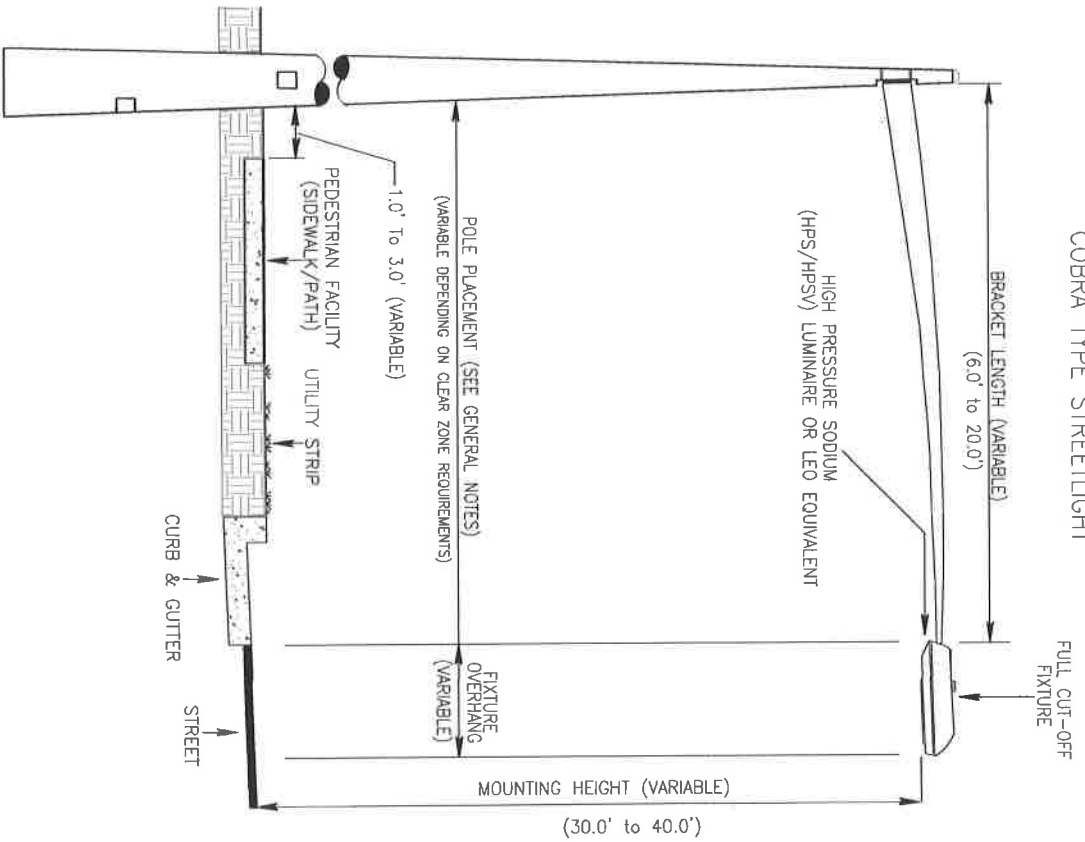

GENERAL NOTES:

- 1) All lighting shall be installed in accordance with the most recent County and VDOT standards. Any deviation shall require approval from the Director of Transportation and VDOT.
- 2) Poles shall be located at a distance equal or greater than the minimum clear zone requirements for different types or class of roadways.
- 3) Poles should be located in an easement and be outside of the VDOT right-of-way.
- 4) Poles shall not be located with the median.
- 5) Poles should not be located in the utility strip.
- 6) Pole locations for streetscapes or locations in front of sidewalks or shared use paths shall be Reviewed and approved by VDOT on a case by-case-basis.
- 7) On ditch section roadways, poles shall be located behind the ditch line.
- 8) On curb section roadways, the poles shall be located a minimum of three feet behind the backside of the curb (measured from the backside of the curb to the face of the pole).
- 9) Poles shall be located a minimum of one foot from the the backside of the sidewalk (measured from the backside of the sidewalk to the face of the pole).
- 10) Poles shall be located a minimum of three feet from a shared use path/paved path (measured from the backside of the trail to the face of the pole).
- 11) Poles shall be located a minimum of three feet behind the guardrail (measured from the backside of the guardrail post to the face of the pole).
- 12) Footing or foundation shown is illustrative only. Standard foundation required by utility company shall be provided.
- 13) Additional County fixture types are available and when requested are reviewed on a case-by-case basis.

Detail No.
650.61

SLI-1



COUNTY OF
PRINCE WILLIAM
VIRGINIA

TYPICAL STREET LIGHT INSTALLATION

Date
6/26/18

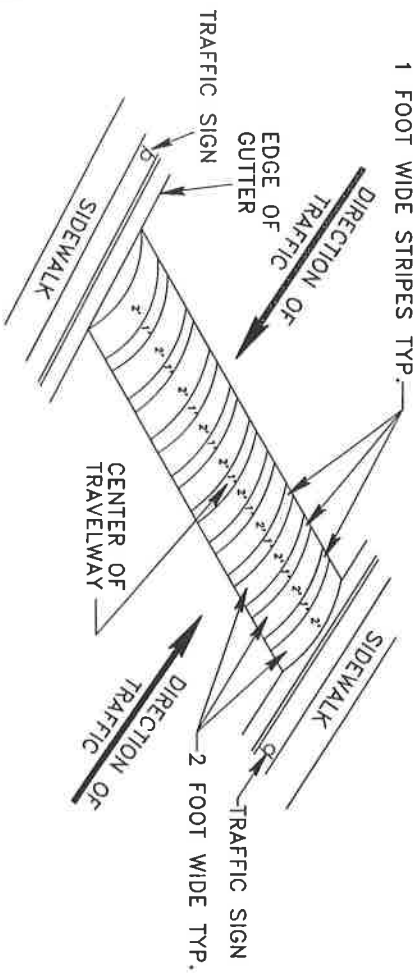

NOTE : NUMBER OF 1 FOOT WIDE STRIPES DEPENDS ON THE WIDTH OF HUMPS. START 1ST STRIPE IN CENTER OF TRAVELWAY.

PLAN VIEW

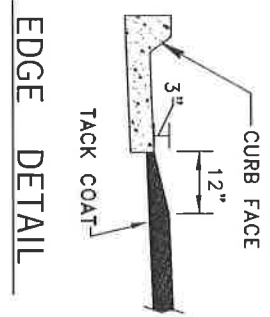

SPECIAL
30" x 30"



W13 - 1
24" x 24"

TYPICAL TRAFFIC SIGN

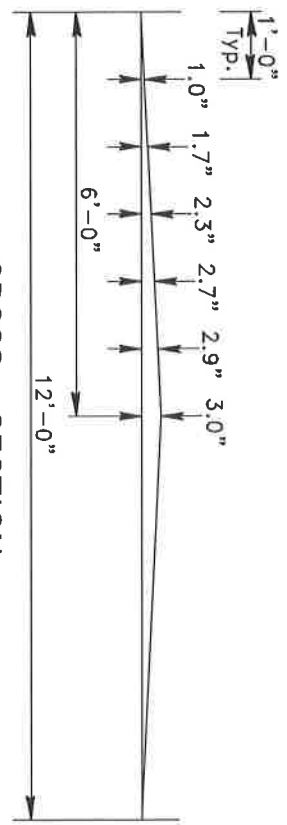

CROSS SECTION

GENERAL NOTES:

- 1) Applicable for use on commercial, shopping center, office and other land use sites approved by the Director of Transportation.
- 2) Speed humps locations shall require approval of the Department of Fire and Rescue and Director of Transportation prior to installation.
- 3) Speed humps should be used in series of 300 to 500 feet spacing.
- 4) Locations of speed humps should avoid manholes, water valves, roof drains, and handicapped crossings.
- 5) Signs and pavement markings shall be in accordance with the MUTCD.

Detail No. 650.62	PTS-1		COUNTY OF PRINCE WILLIAM VIRGINIA	PRIVATE TRAVELWAY SPEED HUMPS	Date 7/15/14
-----------------------------	--------------	--	--	---	-----------------

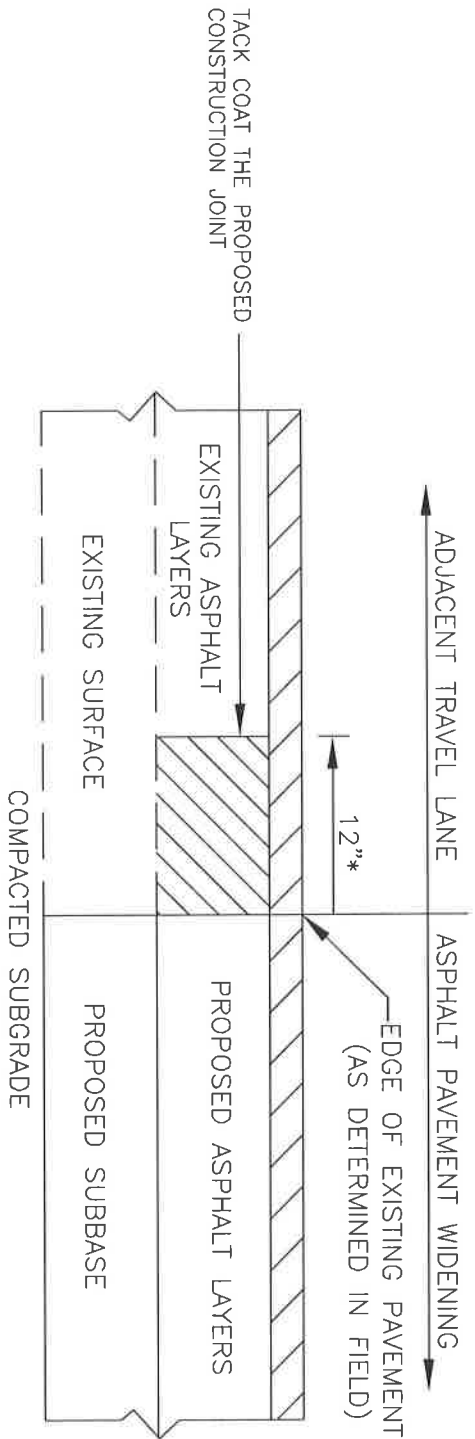

CONSTRUCTION JOINT DETAIL

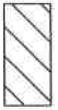

Remove existing asphalt layers to existing subbase and replace with proposed asphalt widening layers.



Proposed minimum 1-1/2 inch thick asphalt surface course (See Note 5).

* Minimum 12 inches or greater as necessary to about the full thickness of existing asphalt layers as determined by cores (See Note 3).

NOTES:

- 1) Asphalt pavement widening shall have a pavement design in accordance with current VDOT procedures and be approved by the Engineer.
- 2) The pavement design for asphalt pavement widening shall meet or exceed the depths and types of the layers of existing pavement. Subsurface drainage of the existing and proposed pavement shall be addressed in the pavement design.
- 3) A minimum of three cores shall be taken along the center of the adjacent travel lane to determine the type and thickness of existing pavement layers. These cores shall be spaced no more than 500 feet apart.
- 4) The adjacent travel lane shall be milled a minimum depth of 1-1/2 inches and replaced with an asphalt surface course to match the proposed pavement widening surface course, unless waived by the Engineer.
- 5) The Engineer may required the milling depth of the existing pavement to be adjusted to achieve an acceptable pavement cross slope and effective surface drainage.
- 6) Existing pavement markings and markers within the project limits shall be restored subject to the approval of the Engineer.
- 7) Final transverse pavement tie-in shall conform to the requirements of Section 315.05 (c) of the specifications except that all joints at tie-in locations shall be tested using a 10-foot straightedge in accordance with the requirements of Section 315.07 (a) of the latest VDOT Road and Bridge Specifications Manual.

Detail No.	APW-1		COUNTY OF PRINCE WILLIAM VIRGINIA	ASPHALT PAVEMENT WIDENING FOR WIDENING SUBJECT TO TRAFFIC	Date 7/15/14
650.63					

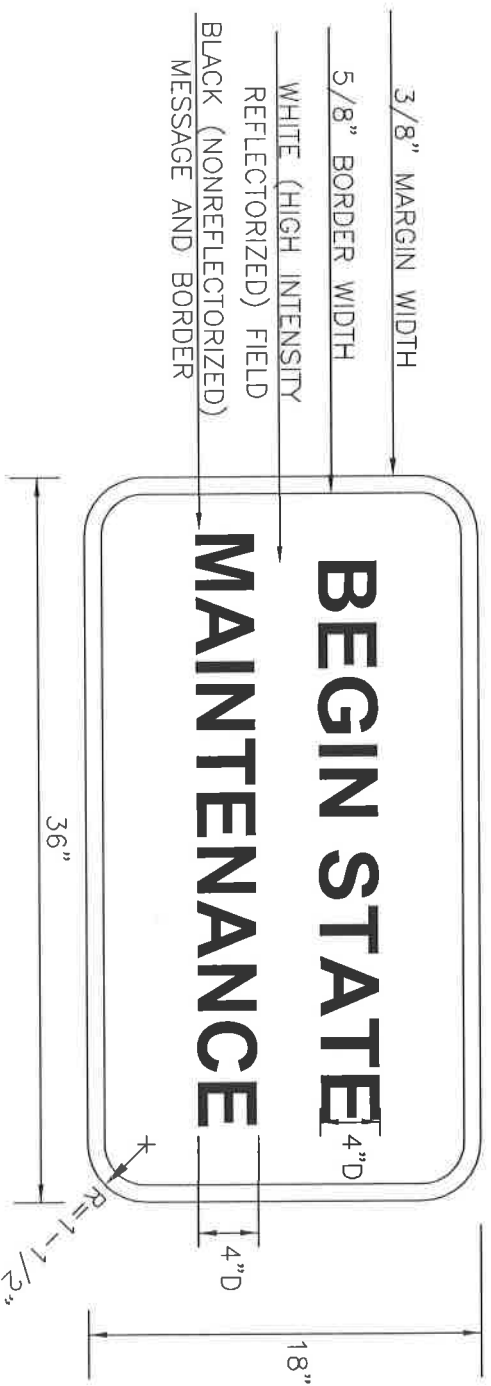

- General Notes:
- 1) The sign shall be erected at the beginning and end of section of routes maintained by the State.
 - 2) Line 1 of the sign shall be changed to read END STATE when erected at the end of State maintained roads.

Detail No.	SMS-1		COUNTY OF PRINCE WILLIAM VIRGINIA	STATE MAINTENANCE ROAD SIGN	Date
650.64					7/15/14